

CASIO
IT-9000WM Series
Quick Start Guide
(Version 1.00)

CASIO Computer Co., Ltd.
Copyright ©2012. All rights reserved.

March 2012

Table of the Contents

	Editorial Record	4
	Preface	5
Chapter	1. Product Overview	6
	1.1 Features at a Glance	6
	1.2 Library	8
	1.3 Development Manuals	9
Chapter	2. Prerequisites	10
	2.1 Skills Required	10
	2.2 Hardware Required	11
	2.3 Software Required	13
Chapter	3. Installing BDK to PC	14
	3.1 Application Development	14
	3.2 Installing CASIO BDK Files	15
	3.3 Installing Library	17
	3.4 Installing Online Help	18
Chapter	4. Connecting Power Supply to Cradle	19
	4.1 HA-L60IO	19
	4.2 HA-L62IO	21
Chapter	5. Connecting IT-9000 to PC	23
	5.1 Connection via USB Cradle	24
	5.2 ActiveSync Connection via USB	25
	5.2.1 Installing ActiveSync for the First Time	25
	5.2.2 If ActiveSync Is Already Installed	32
	5.3 Windows Mobile Device Center via USB	34
	5.4 Connection via WLAN	35
	5.5 Connection via Ethernet Cradle	40
	5.6 Accessing Shared Network Drive on Your LAN	41
	5.7 Direct TCP/IP Connection from Visual Studio	42
Chapter	6. Setting Up the Development Environment	44
	6.1 Installing CAB Files	44
	6.2 Visual Studio 2005	45
Chapter	7. Device Emulator	46
	7.1 Software Required	46
	7.2 Starting Up the Device Emulator	48
	7.3 Using the Device Emulator	49
	7.3.1 IT-9000WM Device Emulator	49
	7.3.2 I/O Simulator	50
	7.3.3 Connecting via ActiveSync	56
	7.4 Debugging Applications	58
Chapter	8. Visual Studio	60
	8.1 Developing in C++	61
	8.2 Developing in VB.NET	65
	8.3 Developing in C#	67
Chapter	9. Resources	70

No part of this document may be produced or transmitted in any form or by any means, electronic or mechanical, for any purpose, without the express written permission of CASIO Computer Co., Ltd. in Tokyo Japan. Information in this document is subject to change without advance notice. CASIO Computer Co., Ltd. makes no representations or warranties with respect to the contents or use of this manual and specifically disclaims any express or implied warranties of merchantability or fitness for any particular purpose.

© 2012 CASIO Computer Co., Ltd. All rights reserved.

Preface

This guide clearly and concisely sets out the information developers need to know to get started with the CASIO IT-9000 series handheld terminals with the integrated Windows Mobile® Version 6.5 OS. The best methods of connecting to your development system are covered and step by step instructions for installing and testing the CASIO Basic Development Kit (BDK) are included.

The purpose of this guide is to get you to the point where you can start development; you should refer to the library manuals for detailed information on the specific APIs.

The words, "the terminal", "the IT-9000", "the IT-9000 series", and "IT-9000 device", used in this reference manual mean IT-9000 series handheld terminal with the integrated Windows Mobile® as its OS unless otherwise noted.

1. Product Overview

1.1 Features at a Glance

IT-9000 has been designed using the new concept of the Human-centered Design Processes and is capable of performing a wide variety of powerful functions.

The following is a brief overview of the features available on the IT-9000 series handheld terminals. For further detail on the hardware specifications, refer to IT-9000 Series Hardware Manual.

Outstanding development environment

- Microsoft® Windows Mobile® 6.5 English Version as the built-in OS
- Visual Studio 2008
- Visual Studio 2005

Various communication systems

- Built-in ultra-small WLAN module compatible with the IEEE802.11b/g standard
- Built-in WWAN module combines GSM, GPRS and EDGE modules with GPS receiver designed for use in transportation and logistics.
- High speed infrared communication with IrDA Version. 1.3
- Bluetooth® Version 2.0
- Serial interface with USB version 1.1 (Host/Client)

Small size, light weight

- Dimensions : Approx. 111.9(W) x 59.7 (D) x246.3 (H) mm
- Weight : Approx. 590 g

Improved durability

- Impact resistance : 1.5 m in height *
- Dust/Water-splash proof : IP67 level (compliant with IEC60529 International Standard)

* The drop durability height is a measured value resulting from actual testing. It does not necessarily guarantee the product from damage.

Capable of scanning industrial standard bar code symbologies

1D:

UPC-A, UPC-E, EAN8(JAN8), EAN13(JAN13), Codabar(NW-7), Code39, Interleaved 2 of 5(ITF), MSI, Code93, Code128(EAN128(1)), ISBT, IATA, Code11, RSS-14, RSS Limited, RSS Expanded, Code32

2D Stacked:

Code49, PDF417, MicroPDF, Codablock F, Aztec, QR Code(Model 2), MicroQR, MaxiCode, DataMatrix(ECC000/050/080/100/140/200), Composite, TLC39, RSS-14 Stacked, RSS Expanded Stacked, CSC

2D Matrix:

Aztec, DataMatrix, Maxicode, QR Code, Micro QR, Chinese Sensible Code (HanXin Code)

CPU, Memory

- High-performance CPU
Marvell® PXA320 Application Processor (runs at maximum 624 MHz)
- Large-capacity memory
RAM : 256 MB
F-ROM : 256 MB

SIM/SAM

ISO7816 IC Card standard
3V, 1.8V SIM card supported

Printer

Method	Dropin-type Thermal line dot
Paper width	80 mm or 58 mm
Printing width	72 mm (for an 80 mm/82.55mm paper) 48 mm (for a 58 mm paper)
Speed	28 lines per second (Max.)
Font Size	“x1”, “x1.5”, “x2”, “x3”, and “x4” sizes are supported.
Font types	ANK/Symbologies (UPC-E, NW-7, Code39, ITF, Code128, OCR-B, user-defined characters x 128)
Dot pitch	0.125mm(8dot/mm)
Dot size	0.22mm (Length) × 0.125mm(Width)

MCR

Application card
F2F Format(ISO7811-2、 ISO7811-6)
The number of the simultaneous uptake trucks
3Tracks (ISO7811-2、 ISO7811-6)

Please refer to a hardware manual for the details

1.2 Library

The IT-9000WM Basic Development Kit ("BDK") provides various libraries including those listed in the table.

Table 1.1

Library	Description	C++	VB C#
System Library	Library that is used to control the system.	Yes	Yes
Imager Library	Library that is used to control the built-in CMOS Imager.	Yes	Yes
NFC Library	Library that is used to control to communicate with IC card.	Yes	Yes
WANGPRS Library	Library that is used to control the built-in WANGPRS module.	Yes	Yes
JPEG Library	Library that is used to handle and manipulate JPEG image functions.	Yes	-
FLINK Library	Library that is used to control and carry out transmission/reception of files between PC and other device.	Yes	Yes
Bluetooth Library	Library that is used to control the built-in Bluetooth module.	Yes	Yes
SAM Library	Library that is used to communicate with the SAM Card.	Yes	Yes
PrinterLibrary	Library that is used to control the Printer.	Yes	Yes
PrinGDI Library	Library that is used to control the built-in Printer module in the print system	Yes	Yes
MCR Library	Library that is used to control the built-in Magnetic Card Reader	Yes	Yes
Camera Library	Library that is used to control the built-in CAMERA module	Yes	Yes

Note:

The abbreviations used in the table are;

- C++ : Visual C++
- VB : Visual Basic .NET
- C# : Visual C# .NET

Table 1.2 shows each file name of the Dynamic Link Library and Dynamic Link Class Library.

Table 1.2

Library	Dynamic Link Library	Dynamic Link Library (Class Library)
System Library	SystemLib.dll	SystemLibNet.dll
Imager Library	ImagerLib.dll	ImagerLibNet.dll
NFC Library	NFCLib.dll	NFCLibNet.dll
WANGPRS Library	WangprsLib.dll	WangprsLibNet.dll
JPEG Library	JpegCe.dll	None
FLINK Library	FlinkLib.dll	MoFlinkLib.dll
Bluetooth Library	BluetoothLib.dll	BluetoothLibNet.dll
SAM Library	SAMLib.dll	SAMLibNet.dll
PrinterLibrary	PrinterLib.dll	PrinterLibNet.dll
PrinGDI Library	Cp780Lib.dll	Cp780LibVB.dll Cp780LibCS.dll
MCR Library	MCRReadLib.dll	MCRReadLibNet.dll
Camera Library	CameraLib.dll	CameraLibNet.dll

1.3 Development Manuals

The IT-9000WM Basic Development Kit ("BDK") provides various development reference manuals as described in the table below.

Table 1.3

Development Manual	Description
Quick Start Guide	This reference manual.
Software Manual	Reference manual that describes software specifications in detail for all the software integrated in the IT-9000 handheld terminal.
Hardware Manual	Reference manual that describes hardware specifications in detail on each dedicated option and the IT-9000 handheld terminal
System Library Manual	Reference manual that describes individual functions in detail for System Library.
Imager Library Manual	Reference manual that describes individual functions in detail for Imager Library.
NFC Library Manual	Reference manual that describes individual functions in detail for NFC Library.
WANGPRS Library Manual	Reference manual that describes individual functions in detail for WANGPRS Library.
JPEG Library Manual	Reference manual that describes individual functions in detail for JPEG Library.
FLINK Library Manual	Reference manual that describes individual functions in detail for FLINK Library.
Bluetooth Library Manual	Reference manual that describes individual functions in detail for Bluetooth Library.
SAM Library	Reference manual that describes individual functions in detail for SAM Library.
PrinterLibrary	Reference manual that describes individual functions in detail for Printer Library.
PrinGDI Library Manual	Reference manual that describes individual functions in detail for PrinGDI Library
MCR Library Manual	Reference manual that describes individual functions in detail for MCR Library
Camera Library Manual	Reference manual that describes individual functions in detail for Camera Library

2. Prerequisites

2.1 Skills Required

The following skills are required by developers aiming to develop application software for the IT-9000 terminal.

- Windows programming
- A good knowledge of one or more of the following.
 - Visual C++ (Native or Manage code)
 - Visual Basic .NET
 - Visual C#
 - Browser based applications (not covered in this guide)

The following skills or experience are also desirable.

- Windows CE devices
- ActiveSync
- Some networking experience

2.2 Hardware Required

The following models of the IT-9000 series and dedicated options are available.

Table 2.1 List of available models

Model no.	Printer	Image Scanner	MCR	W-WAN GPS	W-LAN (802.11 b/g)	Camera	NFC	Extnsion Slot
IT-9000-05E	Yes	-	-	-	Yes	-	Yes	-
IT-9000-05E-CN	Yes	-	-	-	Yes	-	Yes	-
IT-9000-G05E	Yes	-	-	Yes	Yes	-	Yes	-
IT-9000-GMC25E	Yes	Yes	Yes	Yes	Yes	Yes	Yes	-
IT-9000-25E	Yes	Yes	-	-	Yes	-	Yes	-
IT-9000-G25E	Yes	Yes	-	Yes	Yes	-	Yes	-
IT-9000-GC25E	Yes	Yes	-	Yes	Yes	Yes	Yes	-
IT-9000-GM35E	Yes ^{*1}	Yes	Yes	Yes	Yes	-	Yes	-
IT-9000E-MC25E	Yes	Yes	Yes	-	Yes	Yes	Yes	Yes
IT-9000E-C25E	Yes	Yes	-	-	Yes	Yes	Yes	-

Notes:

- Model with "-CN" at the end of its model number is for China.
- Model with "*" at the end of its model number is for USA and Canada.

Table 2.2 List of the dedicated options

Option	Product	Model no.	Remark
Cradle	USB Cradle	HA-L60IO HA-L60IO-CN	
	Ethernet Cradle	HA-L62IO HA-L62IO-CN	
Battery	Battery Pack	HA-G20BAT	
Battery charger	Dual Battery Charger	HA-G32DCHG	
	Cradle-type Battery Charger	HA-L30CHG HA-L30CHG-CN	
	Car Mounted-type Battery Charger	HA-H35CHG	With Car power Cable
AC adaptor (for HA-L60IO, HA-L62IO, HA-L30CHG,)		AD-S42120C-N5 AD-S42120B-N AD-S42120BE-CN	Without power cable accompanied
Cable	USB cable	DT-380USB-A	To connect cradle to PC
	USB cable (Host)	HA-L80USBH HA-L80USBH-CN	
	USB cable (Client)	HA-L81USBH HA-L81USBH-CN	
	USB-Serial cable	HA-L82RSC HA-L82RSC-CN	
Power Cable (for AD-S42120)		AC-CORD-EU	for Europe
		AC-CORD-US	for USA/Canada
		AC-CORD-TW	for Taiwan
		AC-CORD-KR	for Korea
		AC-CORD-AU	for Australia/New Zealand

* The AD-S42120B-N is not sold in the EU or in EFTA member states.

External views of IT-9000 and dedicated options

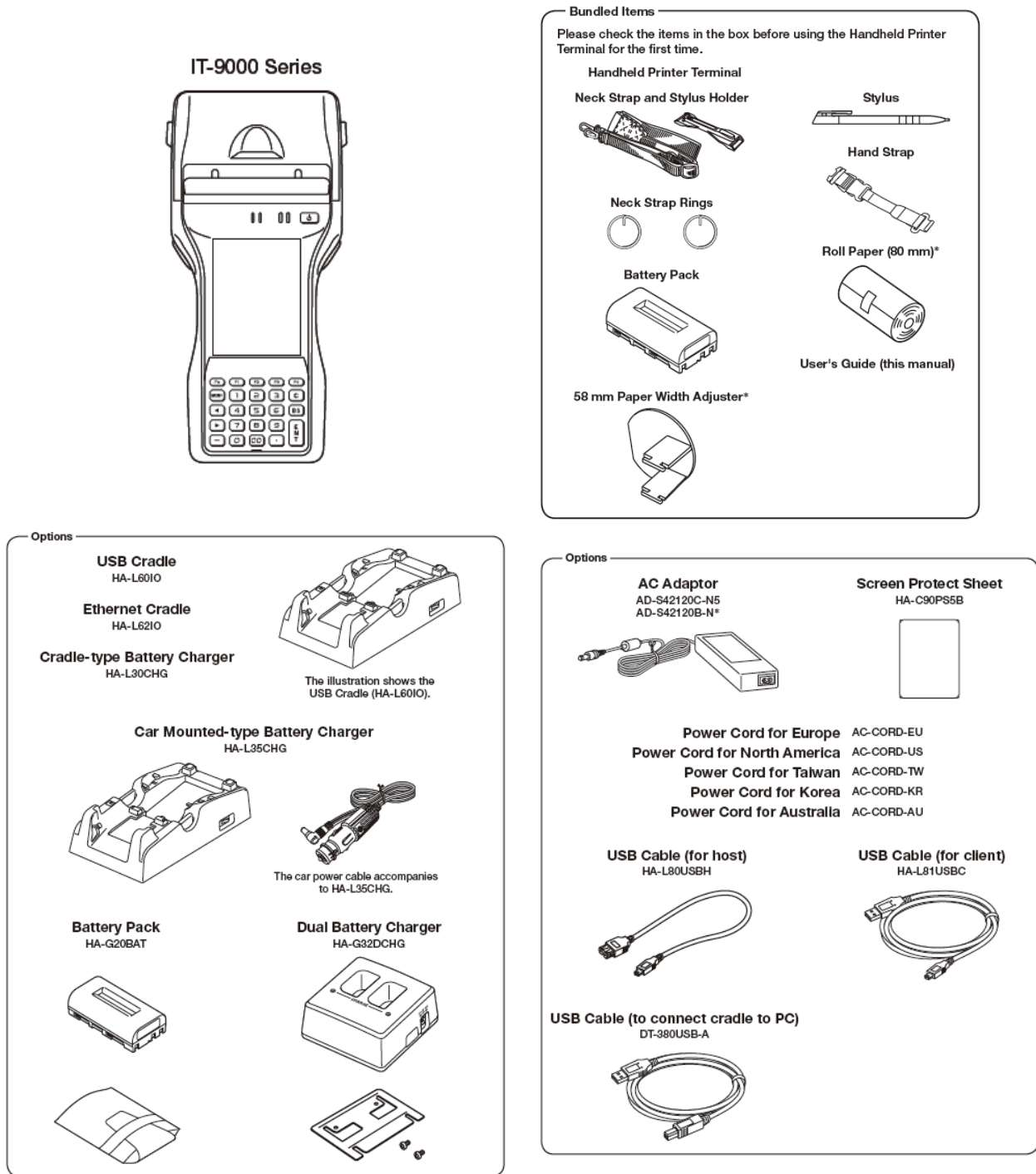

Figure 2.1

2.3 Software Required

The following software tools and libraries are required in order to develop software for IT-9000. Please ensure that you download or purchase the correct Microsoft tools as appropriate.

PC Operating System

- Microsoft Windows XP Professional Service Pack 2 or later
- Or Microsoft Windows Server 2003 Service Pack 1 or later
- Or Microsoft Windows Vista (Business / Ultimate)
- Or Microsoft Windows 7
- Or Microsoft Windows Server 2008

Development platform

Table 2.3

Programming Language	Development Platform
Visual C++	Microsoft Visual Studio 2005 + SP1 or later
Visual Basic .NET	Microsoft Visual Studio 2008 + SP1 or later
Visual C#	

Communication Software

The software to be used depends on Windows XP or Windows Vista or later OS.

- For Windows Vista or later OS
Microsoft Windows Mobile Device Center 6.1 (32 bits) for Windows Vista
<http://www.microsoft.com/downloads/details.aspx?familyid=46F72DF1-E46A-4A5F-A791-09F07AAA1914&displaylang=en>
- Windows XP, Windows Server 2003
Microsoft ActiveSync 4.5 English
Download for free from;
<http://www.microsoft.com/downloads/details.aspx?familyid=9E641C34-6F7F-404D-A04B-DC09F8141141&displaylang=en>

SDK

- Microsoft Windows Mobile 6 Professional SDK (Mandatory)
Download for free from;
<http://www.microsoft.com/downloads/details.aspx?familyid=06111A3A-A651-4745-88EF-3D48091A390B&displaylang=en>
- Microsoft Windows Mobile 6.5 Developer Tool Kit (Not mandatory)
<http://www.microsoft.com/downloads/details.aspx?displaylang=en&FamilyID=20686a1d-97a8-4f80-bc6a-ae010e085a6e>

CASIO IT-9000WM BDK

Download the IT-9000WM BDK from

http://www2.casio.co.jp/system_en/pa/PADealer/

(The site requires your user name and password. Enter your user name and password as issued by CASIO.)

3. Installing BDK to PC

3.1 Application Development

This chapter explains about what you need to set up for the development environment before starting your application development.

1. Installing Development Platform

Install Microsoft's development platform which supports Visual Studio 2008 and Visual Studio 2005.

Install SDK (Microsoft Windows Mobile 6 Professional SDK)

For detail, refer to Chapter 2.3 "Software Required".

2. Installing CASIO BDK to PC

Install CASIO's BDK ("Basic Development Kit") and various libraries if necessary. For installation method, refer to Chapter 3.2 "Installing CASIO BDK Files".

3. Connecting IT-9000 to PC (via either ActiveSync or Windows Mobile Device Center)

Connect IT-9000 to PC via Microsoft's ActiveSync (for Windows XP or Windows Server 2003) or via Windows Mobile Device Center (for Windows Vista or later). For connection method, refer to Chapter 5 "Connecting IT-9000 to PC".

4. Setting up the Development Environment

Transmit the CASIO's libraries to IT-9000.

For detail, refer to Chapter 6 "Setting Up the Development Environment".

5. Installing the Device Emulator

Install the Device Emulator for IT-9000. For installation method, refer to Chapter 7 "Device Emulator". If not necessary to install, go to "6. Application Development" below.

6. Application Development

Now, the application development environment is set up and your development with the development platform can be started. After application is developed, transmit it to the Device Emulator or an actual terminal of IT-9000 via ActiveSync or Windows Mobile Device Center for check on the operability. For application development method and transmitting your application, refer to Chapter 8 "Visual Studio".

3.2 Installing CASIO BDK Files

Download the **CASIO IT-9000WM BDK** installation CD image file from the following site and write it to a CD-ROM media.

http://www2.casio.co.jp/system_en/pa/PADealer/

(The site requires your user name and password. Enter your user name and password as issued by CASIO.)

Notes:

- If your PC runs in the Windows Vista or later OS, first you must disable the User Account Control ("UAC") by following the process below before installing the CASIO BDK Files.
 - Navigate to **Control Panel** → **User Accounts** → **Enable or Disable the User Account Control**. Remove the check on **User Account Control (UAC)** to protect your PC, and then click **OK** button.

Installation Steps

1. When the **CASIO IT-9000WM BDK** CD-ROM is inserted in the drive of PC, the following menu screen appears automatically.



Figure 3.1 The version number in the figure may differ from that of your CD.

2. Click **Installation List** in Figure 3.1. The installation screen appears.

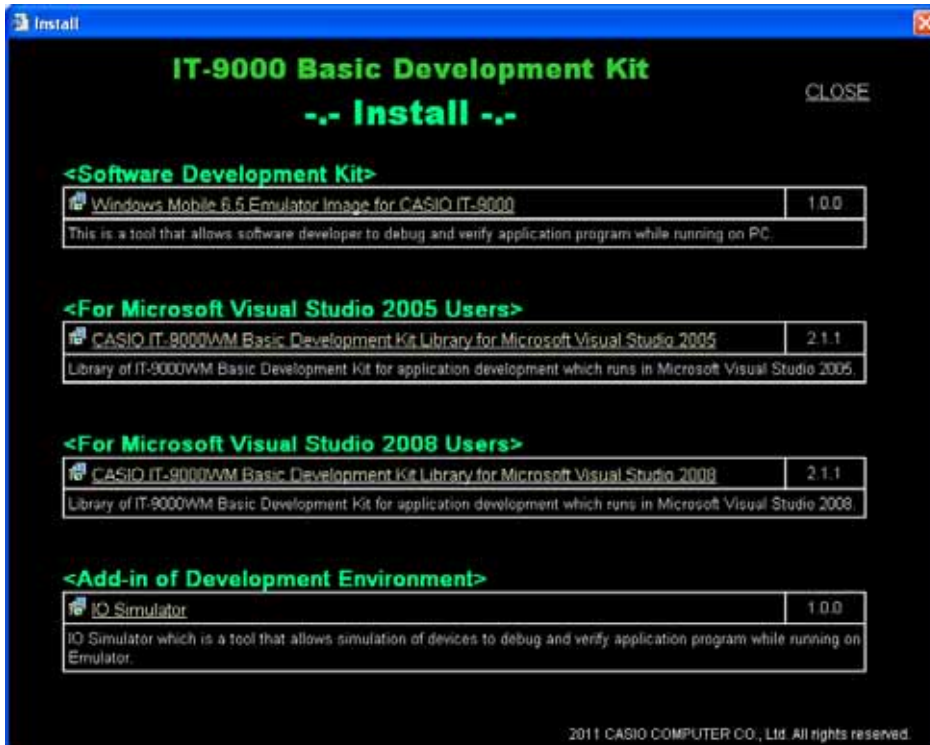

Figure 3.2

3. Choose the component you wish to install in the screen.

3.3 Installing Library

The IT-9000 Library is available for the below development platforms.

- Microsoft Visual Studio 2008
- Microsoft Visual Studio 2005

Notes:

1. The Library header file (*.h) and the Import library file (*.lib) are installed in the following folders respectively.
C:\Program Files\CASIO\MBSYS\include : Header file
C:\Program Files\CASIO\MBSYS\lib\ARMV4I : Import library file
2. The Class library DLL file (*.dll) is installed in the following folder.
C:\Program Files\CASIO\MBSYS\WindowsCE
3. When the Library is installed in PC, the Help file (*.chm) is installed in the following folder.
C:\Program Files\CASIO\MBSYS\HELP

The Help file can be accessed by navigating to **Start** menu → **All Programs** → **CASIO Basic Development Kit** → **Help**

3.4 Installing Online Help

Besides the Help file described in the previous page, the Online Help is also available for the below development platforms. The installation of the Online Help is initiated in the **Installation List**.

- Microsoft Visual Studio 2008
- Microsoft Visual Studio 2005

After the installation is complete, Microsoft Visual Studio starts up. The Online Help file can be accessed by navigating to **Help** → **Contents** menu.

4. Connecting Power Supply to Cradle

4.1 HA-L60IO

Use the dedicated AC adaptor (AD-S42120C) for supplying power to the HA-L60IO USB Cradle. Ensure that you connect the AC adaptor to the cradle before starting communication between IT-9000 and PC via the cradle. Follow the steps below to connect the power supply to IT-9000 using the dedicated AC adaptor.

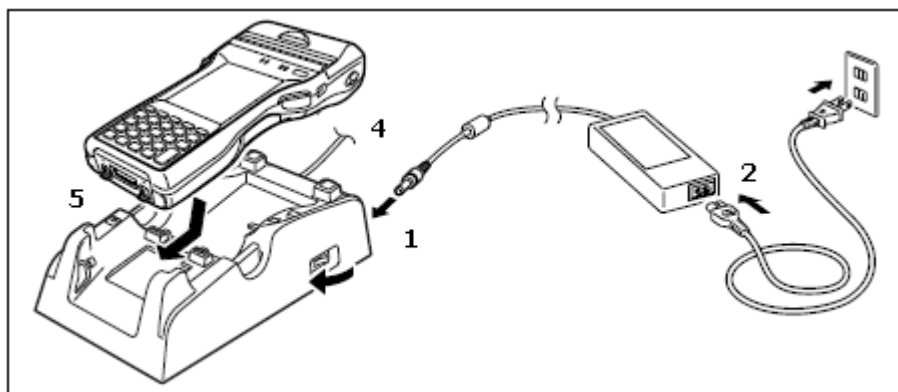
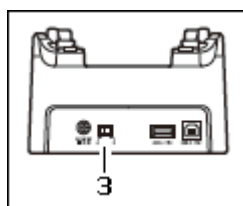

Figure 4.1

1. Plug the AC adaptor into the AC adaptor jack where "DCIN12V" is printed on the back of the cradle.
2. After connecting the power cable to the AC adaptor, plug in the plug to an electrical outlet.
3. Make sure the selector switch on the back of the cradle is set to position B.



A : Using as USB Host.
B : Using as USB Client.

Only the USB device which Casio verified
is supported.

Figure 4.2

4. Connect a USB cable (DT-380USB) to the USB client port on the back of the cradle, and then connect the other end of the cable to the PC. USB host port is used when connecting the cradle with other USB peripheral devices.
5. Align the USB cradle mount holes on the back of IT-9000 with the mount hooks on the cradle after aligning the power/signal contacts on the bottom of IT-9000 with the power/signal contacts of the cradle. The power LED on the front of the cradle will light green if IT-9000 has been properly mounted.

Status of Indicator 1 on IT-9000

- Orange : Charging
- Red : Standby due to battery pack error or the surrounding temperature is out of the range (charging begins when the temperature returns within the correct range.)
- Green : Charging complete

Notes:

- Always remove IT-9000 from the cradle when switching the selector switch on the cradle.
- Never short the power/signal contacts of the cradle. This damages the cradle.
- Do not subject IT-9000 and cradle to vibration or impact during communication. This results in communication being interrupted.
- When mounting IT-9000, securely attach it to the mount hooks of the cradle and check that the power LED on the front of the cradle lights green. Charging the battery pack or communication will not proceed if it is not mounted properly.

4.2 HA-L62IO

Use the dedicated AC adaptor (AD-S42120C) for supplying power to the HA-L62IO Ethernet Cradle. Ensure that you connect the AC adaptor to the cradle before starting communication between IT-9000 and PC via the cradle. Follow the steps below to connect the power supply to IT-9000 using the dedicated AC adaptor.

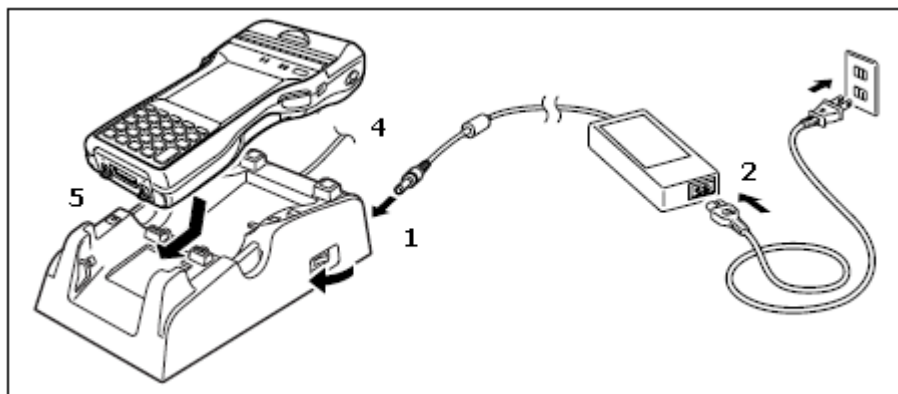
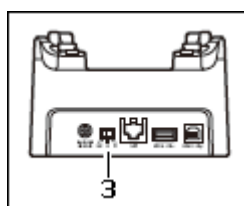

Figure 4.3

1. Plug the AC adaptor into the AC adaptor jack on the back of the Ethernet Cradle.
2. After connecting the AC adaptor to the power cable, plug in the plug of the power cable to an electrical outlet.
3. Set the selector switch on the back of the Ethernet cradle to the port that will be used. Set the switch to "LAN" to use the LAN port or to "USB" to use the USB port.



LAN : Connect to LAN.
A : Using as USB Host.
B : Using as USB Client.

Only the USB device which Casio verified is supported.

Figure 4.4

4. Before using the cradle ports, remove the caps from the ports. When using a LAN, connect one end of the LAN cable to the LAN port and the other end to the PC or hub. When using a USB connection, connect one end of the USB cable (DT-380USB) to the USB port and the other end to the PC.
5. Align the power/signal contacts on the underside of IT-9000 with the power/signal contacts on the Ethernet Cradle and then set IT-9000 into the cradle so that mount holes in the back of IT-9000 are aligned with the mount hooks on the cradle. Once IT-9000 is properly set in the cradle, the power LED on the front of the Ethernet cradle lights green.

Status of Indicator 1 on IT-9000

- | | |
|--------|---|
| Orange | : Charging |
| Red | : Standby due to battery pack error or the surrounding temperature is out of range
(charging begins when the temperature is within the correct range.) |
| Green | : Charging complete |

Notes:

- Always remove IT-9000 from the Ethernet Cradle before changing the selector switch setting.
- Never short out the power/signal contacts of the cradle. This damages the cradle.
- Do not subject the IT-9000 and cradle to vibration or impact during communication. This results in communication being interrupted.
- When mounting IT-9000, securely attach it to the mount hooks of the cradle and check that the power LED on the front of the cradle lights green. Charging battery pack or communication will not proceed if it is not mounted properly.
- The LAN and USB connections cannot be used concurrently.
- Always cap ports that are not being used. Using the Ethernet Cradle while the ports are uncapped can cause damage.

5. Connecting IT-9000 to PC

To make connection establishment with PC, use one of the methods, depending on the OS your PC runs, described below.

- ActiveSync 4.5 (for Windows XP or Windows Server 2003, or any other OS earlier installable)
Use the ActiveSync to connect IT-9000 to PC if the PC runs in Windows XP or Windows Server 2003. The ActiveSync can be downloaded at the URL below.
<http://www.microsoft.com/downloads/details.aspx?familyid=9E641C34-6F7F-404D-A04B-DC09F8141141&displaylang=en>
- Windows Mobile Device Center 6.1 or a later version (for Windows 7, Windows Vista, Windows Server 2008, or OS later installable)
Use the Windows Mobile Device Center to connect IT-9000 to PC if the PC runs in Windows Vista OS. The Windows Mobile Device Center ("WMDC") can be downloaded at the URL below.
<http://www.microsoft.com/downloads/details.aspx?familyid=46F72DF1-E46A-4A5F-A791-09F07AAA1914&displaylang=en>

[For WS2008]

Before installing Windows Mobile Device Center, you need to make the Desktop Experience feature on Windows 2008 active. For further details, refer to the following web site.

Web site:

<http://support.microsoft.com/kb/950169/en-us>

5.1 Connection via USB Cradle

Before making connection using ActiveSync or Windows Mobile Device Center, check the USB Connection settings on the terminal.

Follow the steps below:

1. Navigate to **Start** → **Settings** → **System** tab → **USB Connection**.
2. Tap **Connect Utility** tab.

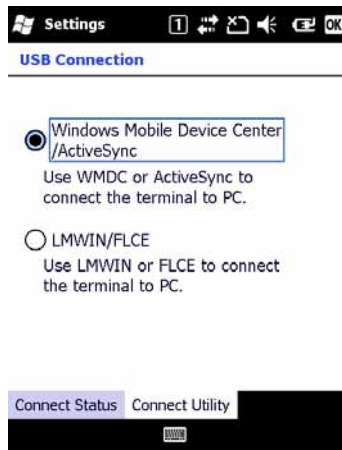

Figure 5.1

3. Confirm that "Windows Mobile Device Center/ActiveSync" is selected. If not, select the radio button and tap **ok**.

5.2 ActiveSync Connection via USB

If you have already installed ActiveSync and connected the IT-9000 to the PC via direct USB, You may skip Chapter 5.2.1. You already have the USB driver and ActiveSync in your development environment. If you do not yet have the cradle driver on your PC, download the USB driver files “wceusbsh.inf” and “wceusbsh.sys” from the CASIO web site and copy them to an appropriate folder.

5.2.1 Installing ActiveSync for the First Time

1. Install ActiveSync first. Run the ActiveSync ‘msi’ file.

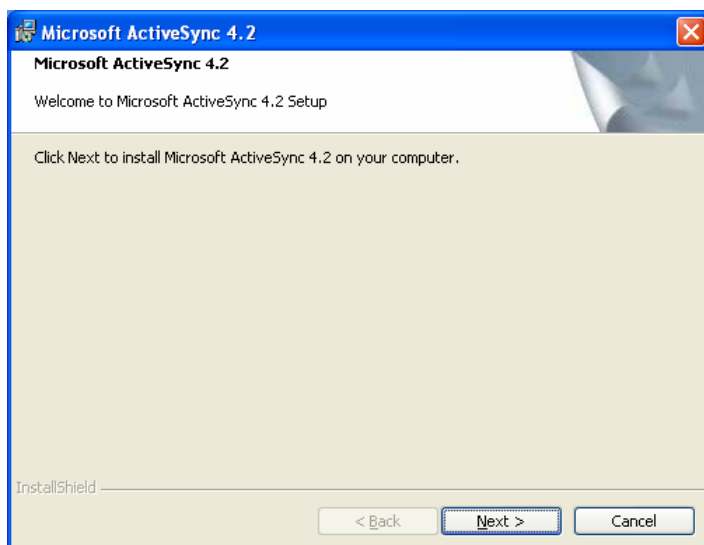

Figure 5.1

2. Click **Install** button.

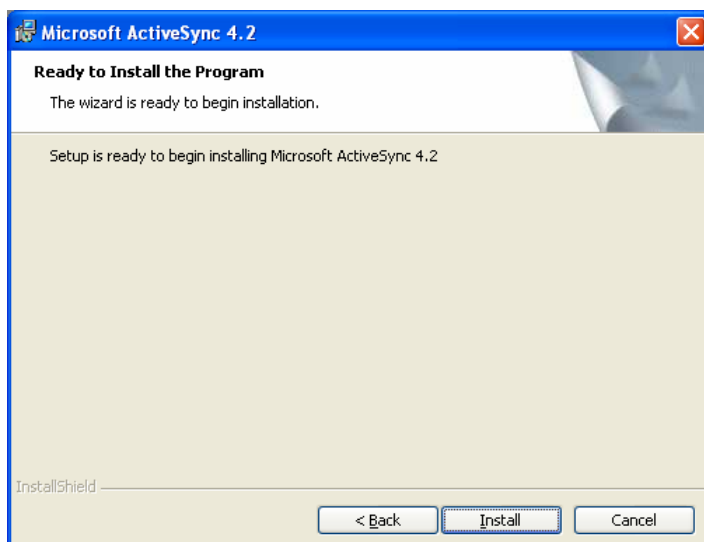

Figure 5.2

3. Pause the installation when the menu in Figure 5. is displayed; you have to install the driver at this point.

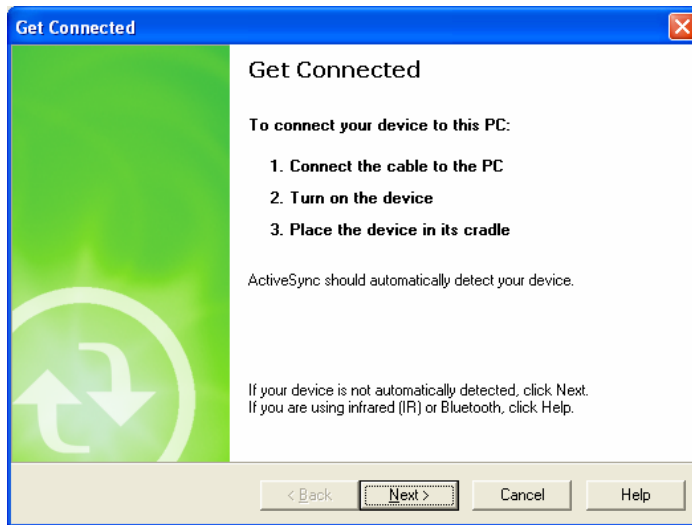

Figure 5.3

4. Connect the USB cable to the PC and the other end to the USB Cradle and also the AC adaptor to the USB Cradle.
5. Put the IT-9000 on the cradle and confirm that the green LED on the front of the cradle is lit. If not, be sure the IT-9000 is positioned firmly on the cradle.
6. When the IT-9000 is mounted on the USB Cradle, a dialog is displayed to prompt you to install the suitable driver. If you have not yet obtained the driver files, see page 16 for detail of what you need to download.
7. Choose **No, not this time** radio button in Figure 5. and then click **Next >** button.



Figure 5.4

8. Then, choose **Install from a list or specific location [Advanced]** radio button in the menu.

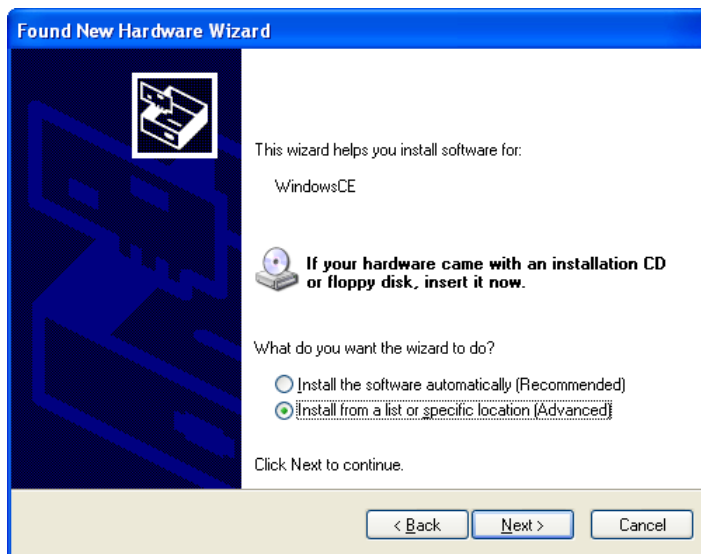

Figure 5.5

9. Click **Next >** button.

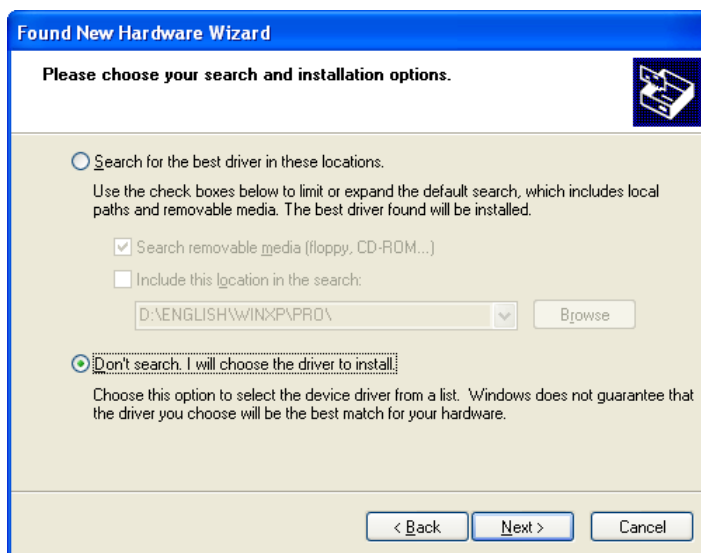

Figure 5.6

10. Choose **Windows CE USB Devices** icon.

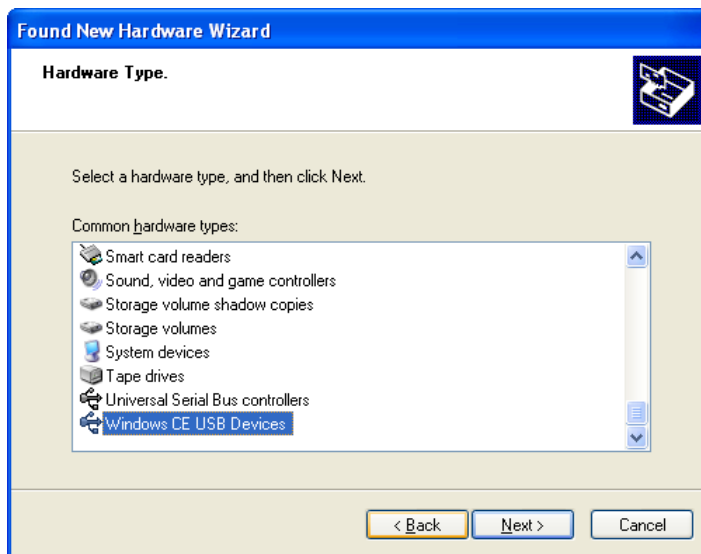

Figure 5.7

11. Click **Have Disk...** button.

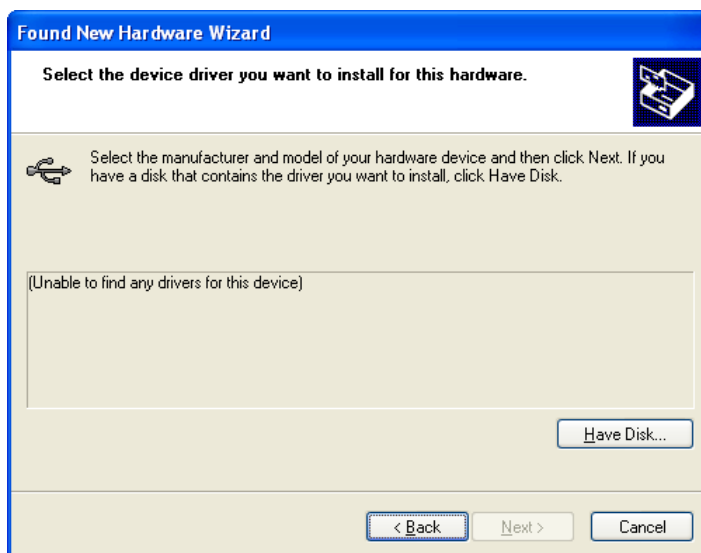

Figure 5.8

12. Click **Browse...** button. Select “wceusbsh.inf” from the folder you created in step 6.

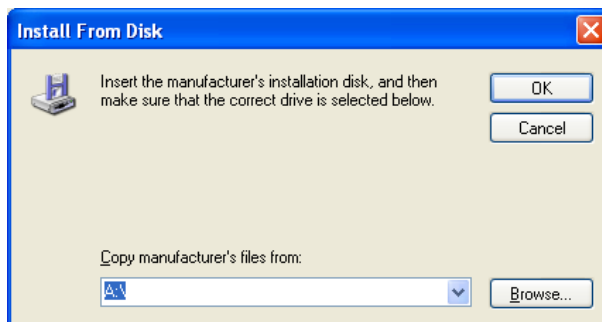

Figure 5.9

13. The installation of the driver will start.

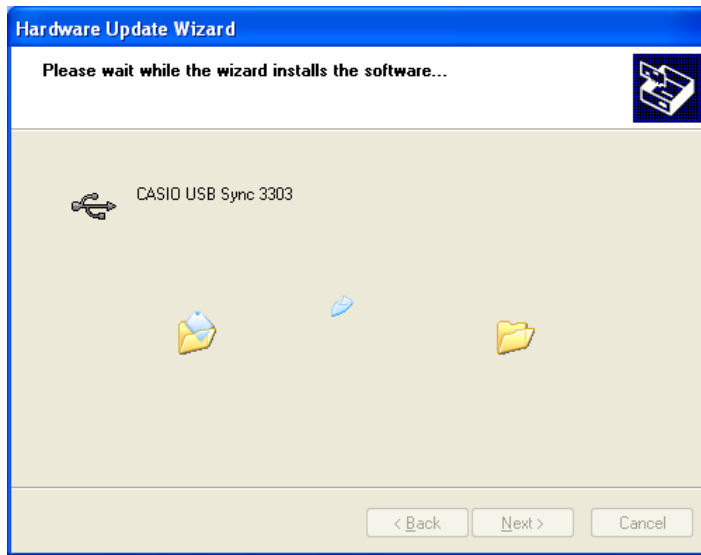

Figure 5.10

14. Click **C**ontinue Anyway button.



Figure 5.11

15. A menu might be displayed to prompt you to install “wceusbsh.sys”. This happens if “wceusbsh.sys” is not in the same folder as “wceusbsh.inf”. Download this file from the CASIO Web Site and follow the prompts to specify the location of “wceusbsh.sys”.

16. Now the installation of the driver is finished.

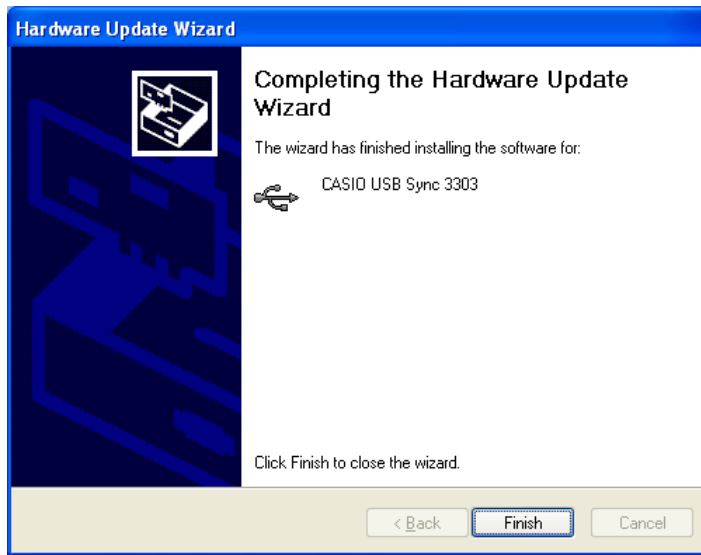

Figure 5.12

17. Now go back to the ActiveSync Installation Wizard that you left on the desktop. Click **Next >** button.

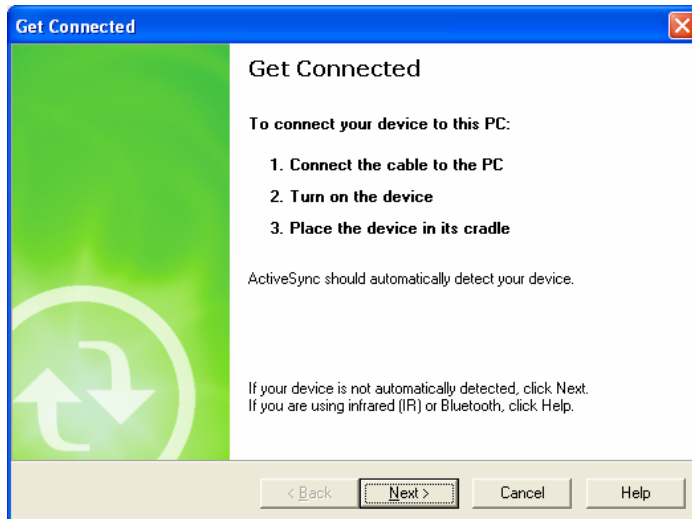

Figure 5.13

18. Now the connection is established. You can choose either partnership option according to your needs. Then click **Next >** button.



Figure 5.14

19. Now the connection is completed. You can start up Visual Studio and create a program and deploy it to the IT-9000.

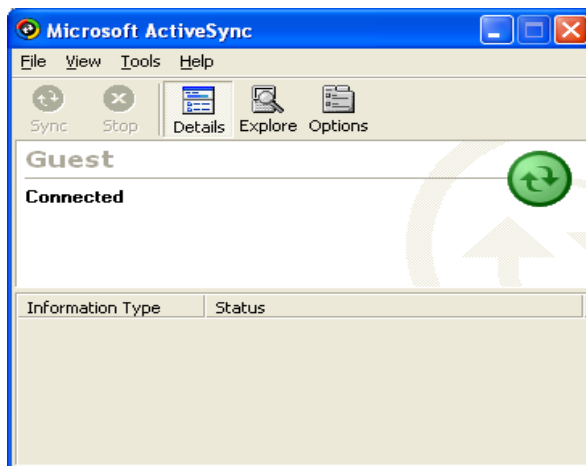

Figure 5.15

Caution

- When you turn the USB interface switch on/off, be sure to remove IT-9000 from the Cradle.
- Make sure not to short the feeding terminals. Shorting circuit of the terminals may cause the defect.
- Don't give any vibration or mechanical shock to the USB interface during communication. If you do so, it may cause communication malfunction.
- When you set the IT-9000 on the Cradle, be sure to securely set it to the fixing hooks on the cradle and check the power indicator LED on the front of the cradle lights on. Improper setting may cause malfunction of communication and/or may not charge the battery.

5.2.2 If ActiveSync Is Already Installed

This is the procedure if ActiveSync is already installed on the PC. You just need to let the PC recognize the IT-9000 and install the cradle driver as in steps 6 to 16 in Chapter 5.2.1.

1. Navigate to **File** → **Connection Settings....** from the menu in ActiveSync. See Figure 5..



Figure 5.16

2. Exclude a check **Allow USB connection with this desktop computer.**

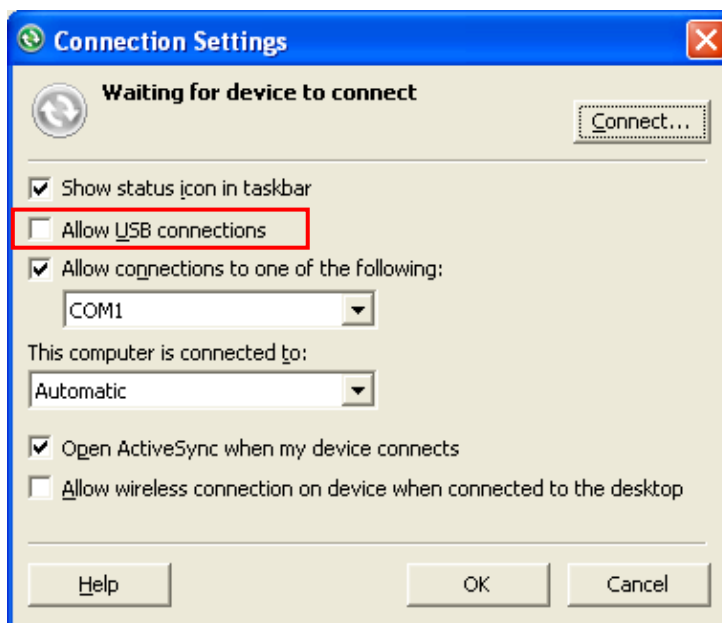

Figure 5.17

3. On the IT-9000, in **Control Panel**, choose the **PC Connection** option. Confirm that PC Connection is set to "USB Default". If not, choose 'USB Default' and tap **OK** button.

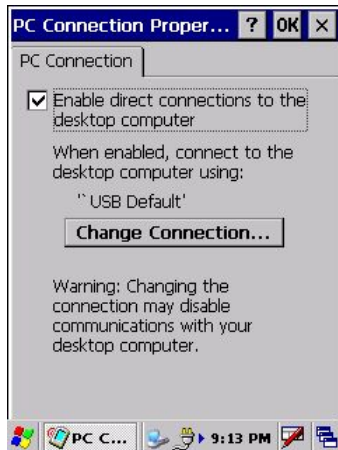

Figure 5.18

4. When the IT-9000 is mounted on the USB Cradle, a menu to prompt to install the driver is displayed. Follow the same steps in Chapter 5.2.1.



Figure 5.19

After driver installation is completed,

- Check "Allow USB connections" in ActiveSync. (See Figure 5.17)
- Dismount the device from the cradle and mount the device on the cradle again.

Caution

- When you turn the USB interface switch on/off, be sure to remove IT-9000 from the Cradle.
- Make sure not to short the feeding terminals. Shorting circuit of the terminals may cause the defect.
- Don't give any vibration or mechanical shock to the USB interface during communication. If you do so, it may cause communication malfunction.
- When you set the IT-9000 on the Cradle, be sure to securely set it to the fixing hooks on the cradle and check the power indicator LED on the front of the cradle lights on. Improper setting may cause malfunction of communication and/or may not charge the battery.

5.3 Windows Mobile Device Center via USB

To establish connection via USB interface with PC runs in Windows Vista, use Windows Mobile Device Center ("WMDC"). The IT-9000 is setting to ActiveSync/WMDC by default.

Follow the steps below:

1. Install WMDC to the PC, if not installed.
2. Connect the USB cable to the PC and the other end to the USB Cradle and also the AC adaptor to the USB Cradle.
3. Make sure the selector switch on the back of the cradle is set to position B.
4. Put IT-9000 on the cradle and confirm that the green LED on the front of the cradle is lit. If not, be sure IT-9000 is positioned firmly on the cradle.
5. Follow a message appeared in the WMDC on the PC.

5.4 Connection via WLAN

To establish communication between IT-9000 with WLAN module integrated (see Table 2.1 for applicable models) and PC via WLAN configuration, follow the steps, 1 to 6, below to set up a WLAN configuration on IT-9000. After setting up the configuration, be sure to perform a site survey prior to starting communication via WLAN.

1. Navigate to **Start** → **Settings** → **Connection** tab → **WLANConfig** and then tap **IP** tab.

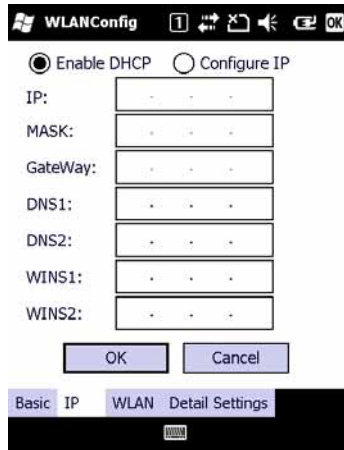

Figure 5.20

Table 5.1

Parameter	Description
Enable DHCP or Configure IP	Determines "Enable" or "Disable" for DHCP.
IP	Determines IP address.
MASK	Determines subnet mask.
GateWay	Determines default gateway.
DNS1	Determines primary DNS address.
DNS2	Determines secondary DNS address.
WINS1	Determines primary WINS address.
WINS2	Determines secondary WINS address.

If any of the settings in Figure 5. is omitted, the process described in the following table will automatically take place in the field.

Table 5.2

Parameter	Nothing is set (DHCP)	"Configure IP" is set
Enable DHCP or Configure IP	"Enable DHCP" is assumed.	"Configure IP" is set.
IP	Does not determine IP address.	Entered address is set as is.
MASK	Does not determine subnet mask.	Entered address is set as is.
GateWay	Does not determine gateway.	Entered address is set as is.
DNS1	Does not determine primary DNS address.	Entered address is set as is.
DNS2	Does not determine secondary DNS address.	Entered address is set as is.
WINS1	Does not determine primary WINS address.	Entered address is set as is.
WINS2	Does not determine secondary WINS address.	Entered address is set as is.

2. Tap **Basic** tab. Set up each parameter in the tab by referring to the descriptions for the parameters in Table 5.3.

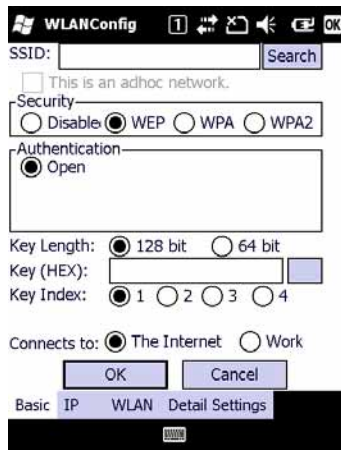

Figure 5.21

Table 5.3

Parameter	Description								
SSID	Enter the SSID of the network you want to connect to.								
Security	<table border="1"> <tr> <td>Disable</td> <td>None.</td> </tr> <tr> <td>WEP</td> <td>Open in Authentication field.</td> </tr> <tr> <td>WPA</td> <td>PSK in Authentication field (if selected, the Key field must be set also.)</td> </tr> <tr> <td>WPA2</td> <td>EAP-PEAP in Authentication field EAP-TLS in Authentication field</td> </tr> </table>	Disable	None.	WEP	Open in Authentication field.	WPA	PSK in Authentication field (if selected, the Key field must be set also.)	WPA2	EAP-PEAP in Authentication field EAP-TLS in Authentication field
Disable	None.								
WEP	Open in Authentication field.								
WPA	PSK in Authentication field (if selected, the Key field must be set also.)								
WPA2	EAP-PEAP in Authentication field EAP-TLS in Authentication field								
Key	<p>Enter 26 (maximum) alphanumeric digits (13 hex pairs) in the Key field if 128 bit radio button is selected. Or, enter 10 (maximum) alphanumeric digits (5 hex pairs) in the Key field if 64 bit radio button is selected.</p> <p>The field displays the number of characters that have been entered. ***** in the field implies that the key has been extracted from the ini file. If ***** in the field is edited, a new key has been deemed to be set. Or, if it has never been edited, the key extracted from the ini file becomes effective as is.</p>								

If **EAP-PEAP** radio button in Authentication field is selected, tap the **EAP-Properties** button that appears when selecting the **EAP-PEAP** radio button to set also the following parameters.

Table 5.4

Parameters in EAP-Properties screen	Description	Default
User name	Input a user name in alphanumeric (maximum 100 alphanumeric).	None
Password	<p>Input a password in alphanumeric (maximum 100 alphanumeric).</p> <p>***** in the field implies that the password has been extracted from the ini file. If ***** in the field is edited, a new password has been deemed to be set. Or, if it has never been edited, the password extracted from the ini file becomes effective as is.</p>	None
Domain	Input a domain in alphanumeric (maximum 100 alphanumeric).	None
Validate server certificate	<p>Set up the requisition for server certificate.</p> <p>With check mark : certificate is required.</p> <p>Without check mark: certificate is not required.</p>	Certificate is not necessary

If **EAP-TLS** radio button in Authentication field is selected, tap the **EAP-Properties** button that appears when selecting the **EAP-TLS** radio button to set the following settings.

Table 5.5

Parameters in EAP-Properties screen	Description	Default
User name	Input a user name in alphanumeric (maximum 100 alphanumeric).	None
Certificate	Select a client certificate installed already (maximum 100 alphanumeric). Search button in the field will display a list of installed client certificates. Select one by highlighting it.	None
Domain	Input in alphanumeric (maximum 100 alphanumeric)	None
Validate server certificate	Set up the requisition for server certificate. With check mark : certificate is required. Without check mark : certificate is not required.	Certificate is required.

3. Tap **WLAN** tab.

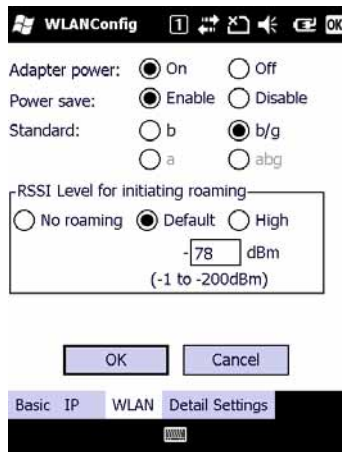

Figure 5.22

Table 5.6

Field / Radio Buttons	Description		Default
Adapter power	On	Enable power to the integrated WLAN module.	Yes
	Off	Disable power to the integrated WLAN module.	
Power save	Enable	Enable power save mode for the WLAN module.	Yes
	Disable	Disable power save mode for the WLAN module.	
Standard	b	Set up IEEE802.11b standard effect.	
	b/g	Set up IEEE802.11b/g standard effect.	Yes
RSSI Level for initiating roaming	No roaming	Set up "-100 dBm" for roaming starting threshold level, a level where communication via WLAN is practically impossible, so that roaming should not be carried out.	
	Default	Set up "-78 dBm" for the roaming starting threshold level.	Yes
	High	Set up "-72 dBm" for roaming starting threshold level, for faster (more frequent) roaming	

4. Tap **Detail Settings** tab.

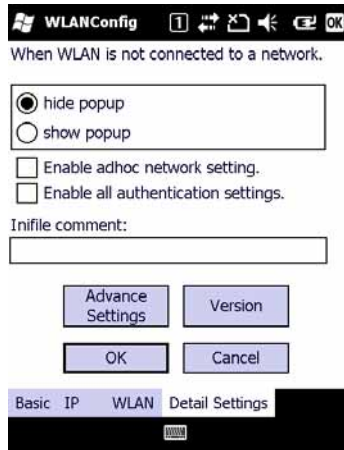

Figure 5.232

Table 5.7

Field / Radio Buttons		Description	Default
When WLAN is not connected to a network	hide popup	Hides popup window when WLAN is not connected to a network.	Yes
	show popup	Shows popup window when WLAN is not connected to a network.	
Enable AdHoc network setting		With check mark : enable the setting. Without check mark : disable the setting.	Yes
Enable all authentication settings		With check mark : enable the setting. Without check mark : disable the setting.	Yes
Infile comment		Enter a comment of up to 100 characters to be written in the ini file.	None

5. If **OK** button is clicked, the screen in Figure 5.243 appears. Tap **OK** button to perform a reset on the terminal so that the setting takes effect.

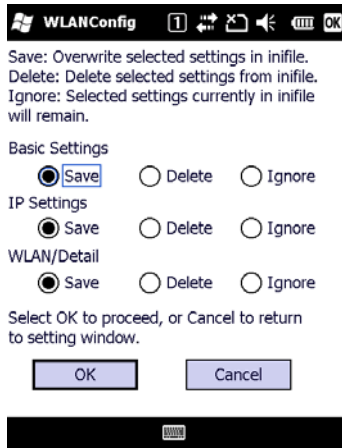

Figure 5.243

6. Check to make sure that the connection has been established using the **NetSearch** utility, and then navigating to the **Ping** function in there. Enter HostName first and then tap **Ping** to check that you are connected to the network correctly.

5.5 Connection via Ethernet Cradle

This chapter describes how to establish a high speed LAN connection on the WLAN non-integrated models with HA-L62IO Ethernet cradle.

Follow the steps below:

1. Connect the dedicated AC adapter to the Ethernet cradle as described in Chapter 4.2.
2. Connect one end of the network cable to the Ethernet cradle and the other end to the network hub.
3. Make sure the selector switch on the back of the HA-L62IO Ethernet cradle is set to the position "LAN".
4. Place IT-9000 in the cradle and navigate to **Start** → **Settings** → **Connections** tab → **Network Cards**.
5. The following screen appears. Double tap "AX88772".



Figure 5.25

6. The following TCP/IP screen appears. Set up all the parameters in **IP Address** and **Name Servers** tabs as required and tap **ok** button.



Figure 5.46

7. If the connection is established correctly, the icon (🌐) in the Taskbar changes to (🌐).

5.6 Accessing Shared Network Drive on Your LAN

Assuming you have a valid network connection established, you can access shared drives on your PC from the **File Explorer** on IT-9000. The following shows the steps to initiate this.

1. Configure a network connection on IT-9000.
2. Double tap My Device.
3. Type \\xxxx\ where xxxx is the network name of the PC.
4. A network logon dialog box will appear. Enter a valid User ID, Password and Network Domain.
5. Any shared network drives on the target PC will be displayed and you will be able to copy files freely between them and IT-9000.

5.7 Direct TCP/IP Connection from Visual Studio

If you have a network connection to IT-9000 (for example, via WLAN or the Ethernet cradle) then you can establish a direct link to the development PC without using ActiveSync.

For Visual Studio 2005

1. Download the files listed below to IT-9000.
 - Clientsshutdown.exe
 - ConmanClient2.exe
 - CMAccept.exe
 - DeviceDMA.dll
 - eDbgTL.dll
 - TcpConnectionA.dll

The source folder in the PC:

C:\Program Files\Common Files\Microsoft Shared\CoreCon\1.0\Target\wce400\armv4i

The destination folder in IT-9000:

\Windows

2. Run **ConmanClient2.exe** on IT-9000.
3. Set the device IP address in Visual Studio 2005.
4. Navigate to **Tools** in the main menu of Visual Studio 2005 → **Options...** → **Device Tools** → **Devices**.
5. Choose **Windows Mobile 6 Professional Device** in the pull-down menu of **Devices:** and click **Properties...**
6. Click **Transport:** to access **Configure...** and set up **Device IP address** as shown in Figure 5.5.

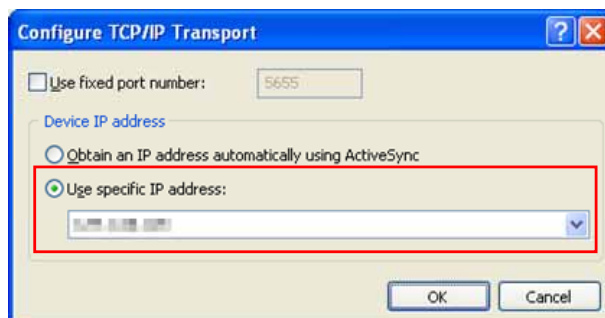

Figure 5.57

7. Run **CMAccept.exe** on IT-9000.
8. Navigate to **Tools** in the main menu of Visual Studio 2005 → **Connect to Device...**

9. Choose **Windows Mobile 6 Professional Device** in the list of **Devices:** and click **Connect** button. The screen in Figure 5.6 if appear indicates the success of connection establishment.

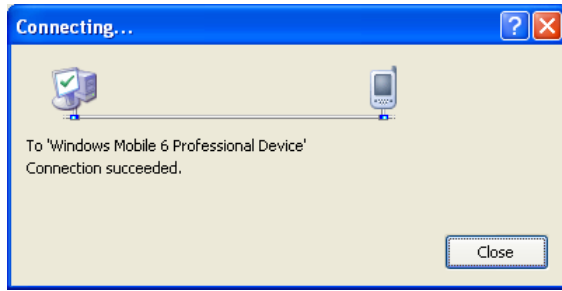

Figure 5.68

6. Setting Up the Development Environment

6.1 Installing CAB Files

1. After installing the library files, the CAB files in Table 6.1 will be installed in the folder below.

C:\Program Files\CASIO\MBSYS\CAB

Table 6.1

Library	CAB file	Preinstalled
System Library	en_SystemLibWM.ARMV4I.CAB	Yes
Imager Library	en_ImagerLibWM.ARMV4I.CAB	Yes
WANGPRS Library	en_WANGPRSLibWM.ARMV4I.CAB	No
JPEG Library	enJPEGWM.ARMV4I.CAB	Yes
FLINK Library	en_FlinkWM.ARMV4I.CAB	Yes (note 2)
NFC Library	en_NFCLibWM.ARMV4I.CAB	Yes
Bluetooth Library	en_BluetoothLib.ARMV4I.CAB	No (note 3)
SAM Library	en_SAMLib.ARMV4I.CAB	Yes
Printer Library	en_PrinterLib.ARMV4I.CAB	Yes
PrinGDI Library	en_PrinGDILib.ARMV4I.CAB en_PrinGDILibWM.ARMV4I.CAB	Yes
MCR Library	en_MCReadLib.ARMV4I.CAB en_MCReadLibWM.ARMV4I.CAB	Yes
Camera Library	en_CameraLib.ARMV4I.CAB en_CameraLibWM.ARMV4I.CAB	Yes

Notes:

1. The library with "Yes" in "Preinstalled" column is preinstalled in IT-9000 and in the Device Emulator. Thus, it is not necessary to install it, unless it has been updated or changed.
2. The CAB file, en_FlinkWM.ARMV4I.CAB, in the table does not operate for IT-9000. Use the FlinkLib.dll installed by default in the terminal.
2. Copy all the CAB files in Table 6.1 to any folder on IT-9000 via ActiveSync.
3. Carry out each CAB file.
4. When the installation starts, the installation status will appear.

6.2 Visual Studio 2005

The procedures for remote-debug using IT-9000 in the development of VB.NET and/or C# application are described in this section.

Follow the steps in Chapter 5 "Connecting IT-9000 to PC" before checking the steps below to confirm that you can connect to IT-9000 from Visual Studio 2005.

1. Establish connection with IT-9000 via ActiveSync.
2. Open the application project for VB.NET or C# in Visual Studio 2005.
3. Choose **Windows Mobile 6 Professional Device** in the pull-down menu box.

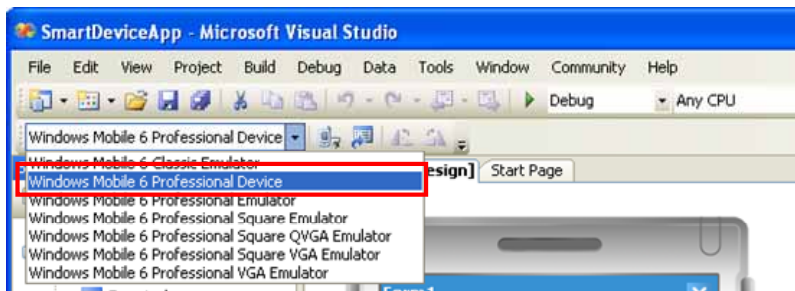

Figure 6.1

4. Click the button shown in the red box below (see Figure 6.2) to make sure that Visual Studio 2005 has recognized the connection established with IT-9000 via ActiveSync. If it does not, start up ActiveSync again to establish connection.

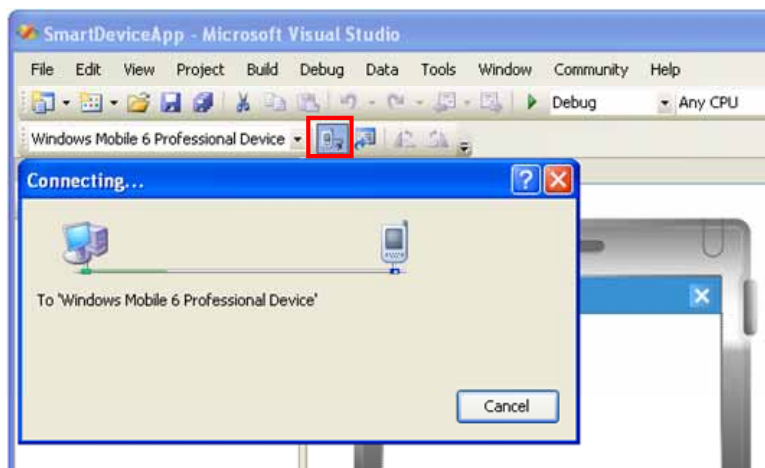

Figure 6.2

5. You will now be able to deploy solutions and also debug applications on the attached IT-9000 using the Visual Studio 2005 debugging features.

7. Device Emulator

The **Device Emulator** provides application developers with an environment that, without having the actual terminal available, allows them to debug basic functions and performance of an application at source level by stepping through the code.

7.1 Software Required

The **Device Emulator** requires the software(s) listed below before installing the emulator.

- ActiveSync 4.5 (If required)
<http://www.microsoft.com/downloads/details.aspx?familyid=9E641C34-6F7F-404D-A04B-DC09F8141141&displaylang=en>
- Visual Studio 2008 or Visual Studio 2005 (Mandatory)
- Microsoft Device Emulator 3.0 (If required)
<http://www.microsoft.com/downloads/details.aspx?displaylang=en&FamilyID=a6f6adaf-12e3-4b2f-a394-356e2c2fb114>
- Windows Mobile 6 Professional SDK Refresh
<http://www.microsoft.com/downloads/details.aspx?familyid=06111A3A-A651-4745-88EF-3D48091A390B&displaylang=en>
- Windows Mobile 6 Emulator Image for CASIO IT-9000 (Mandatory)
- IO Simulator (Mandatory)

Notes:

To use Microsoft Device Emulator 3.0, follow the steps below.

- Install the IT-9000 ExportSDK and Device Emulator of the IT-9000 BDK.
- Download Microsoft Device Emulator 3.0 and install it.
- Edit the following file and save the changes made.
C:\Program Files\Windows CE Tools\wce600\IT-9000\Emulation\IT-9000 QVGA.cdes
C:\Program Files\Windows CE Tools\wce600\IT-9000\Emulation\IT-9000 VGA.cdes

Before you change, the default parameter in the file is described as follows.

```
[Emulator]
module=DevEmu500.exe
```

Change the parameter to the one below. Be sure to describe the whole parameter in single one line.

```
[Emulator]
module=C:\Program Files\Microsoft Device Emulator\1.0\DeviceEmulator.exe
```

You can substitute the Device Emulator Version 3.0 released in Visual Studio 2008 for an engine of Device Emulator included in IT-9000 BDK by the mentioned procedure above.

Case of using after Windows Vista OS

If you use OS after Windows Vista (Windows 7 or Windows Server 2008), please set device emulation and I/O simulator as administrator.

Please check “Run this program as an administrator” of property from opening Explorer.
(Ex. Execute I/O simulator in Windows Vista as administrator.)

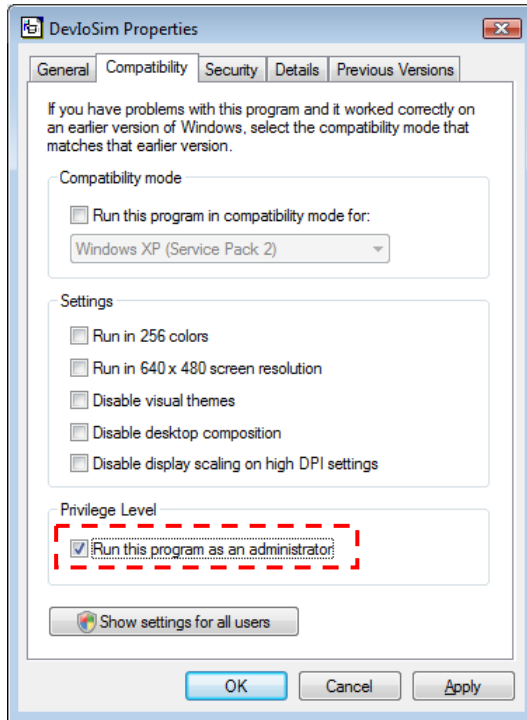

Figure 7.1

These program have installed the following location as default setting.

- Device emulator
C:\Program Files\Microsoft Device Emulator\1.0\DeviceEmulator.exe
- I/O simulator
C:\Program Files\Common Files\CASIO\Emulator\DevIoSim.exe

7.2 Starting Up the Device Emulator

After installing all required software described in Chapter 7.1, follow the steps below to start up the **Device Emulator** on your PC.

1. Navigate to Start menu → **All Programs** → **CASIO Device Emulator** and click **IT-9000WM**.
2. Make sure that the **IT-9000WM Device Emulator** has started up on the screen. See Figure 7.2.
3. Navigate to Start menu → **All Programs** → **CASIO Device IO Simulator** and click **IO Simulator**.
4. Make sure that the **IO Simulator** has started up on the screen. See Figure 7.3.
5. When both Figure 7.2 and Figure 7.3 appear on your PC, you are ready to use the emulator.



Figure 7.2 IT-9000WM Emulator

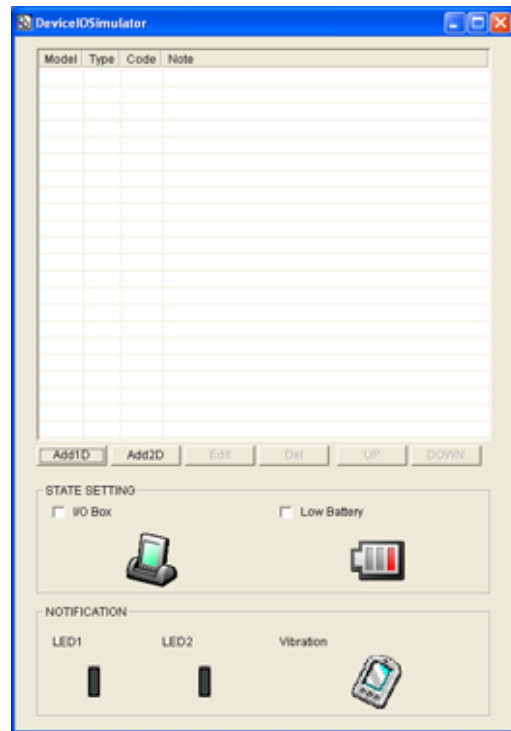

Figure 7.3 I/O Simulator

Terminology of **Emulator** and **Simulator**;

The **Emulator** described in this reference manual is a software application that behaves in a very similar way to the actual device by imitating individual hardware components or protocols present in the actual hardware.

On the other hand, the **Simulator** is also a software application that logically integrates application programming interfaces ("API") and certain other functions to allow debugging of the application program using external events. The **Emulator** performs in a pseudo CPU and hardware environment and it is impossible for the application to recognize whether it is in the actual device environment or pseudo environment. However, actions carried out by the **Simulator** are not as alike to those performed by actual components but merely mimic them very closely.

7.3 Using the Device Emulator

7.3.1 IT-9000WM Device Emulator

The **IT-9000WM Device Emulator** emulates various operations carried out by the actual IT-9000 on the PC's screen such as mouse operation, input on PC's keyboard, displaying execution of applications, and operations by actual devices such as the scanner. Figure 7.4 shows an emulated IT-9000 on the screen of a PC.



Figure 7.4

Key Input

The emulator offers key input capability similar to that of the actual IT-9000. For instance, a key on the emulated keyboard of IT-9000 on the screen (see Figure 7.4) can be clicked with PC mouse as well as key input made directly on the PC's keyboard.

Reading Bar Codes

The emulator enables bar codes pre-registered in the I/O Simulator (see Figure 7.3) to be input when clicking Trigger key on the emulated keyboard (see Figure 7.4). Note however that the Trigger key must be continuously pressed for a second or more otherwise an incorrect key input may result.

Sound

The emulator offers beep and sound capability similar to that of the actual IT-9000.

7.3.2 I/O Simulator

The **I/O Simulator** simulates registration of bar codes, generation of low battery warning, detection of terminal being mounted on the cradle.

Registration of bar code symbologies

1. Registration

Click **ADD1D** or **ADD2D** button (circled in red in Figure 7.5) to go into the bar code registration mode.

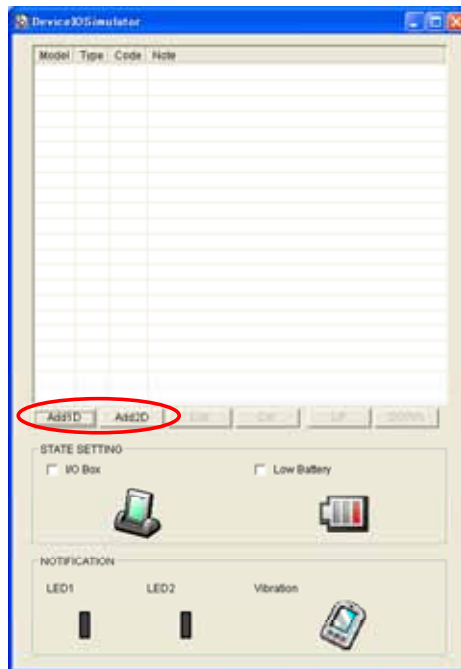

Figure 7.5

2. Bar code registration

Choose a bar code symbology in the **Code Type** pull-down menu that you wish to register in the **I/O Simulator**.

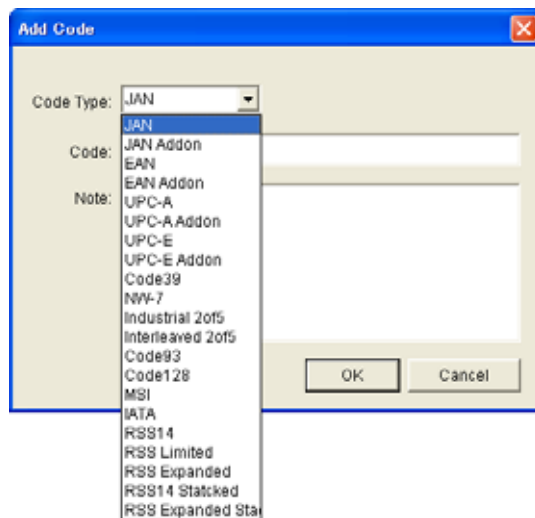

Figure 7.6

- Registration of bar code and note
Enter bar code data in the **Code** field (see Figure 7.7) and a note about the bar code in the **Note** field if necessary. Click **OK** button to complete the bar code registration.

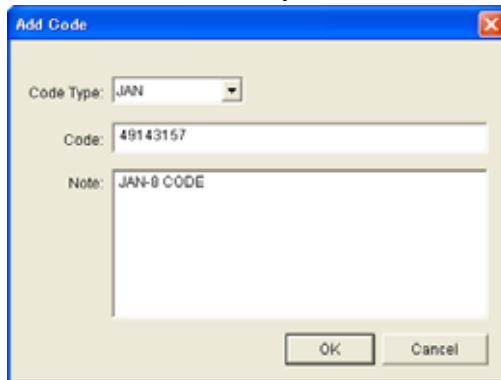

Figure 7.7

- Completion of registration
After completion of the bar codes registration, the screen in Figure 7.8 shows a list of bar codes that have been registered in the **I/O Simulator**. Prior to debugging with the **Device Emulator**, make sure that you register all bar codes you wish to use in debugging.

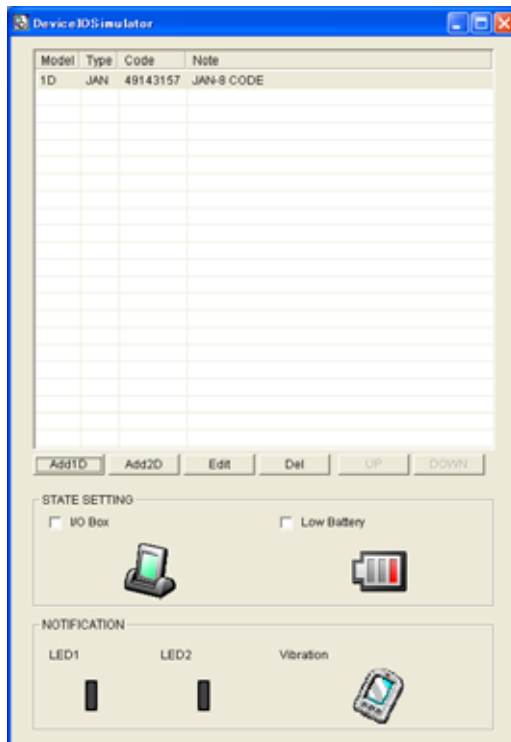

Figure 7.8

5. Editing registered bar code content

Highlight a bar code in the list of registered bar codes (see Figure 7.8) and click **Edit** button. Figure 7.9 appears for editing the bar code and its information.

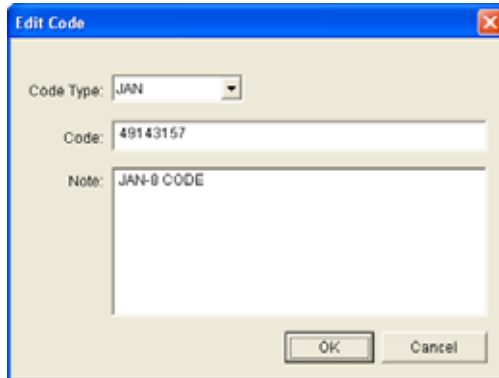

Figure 7.9

6. Deleting registered bar code content

Highlight a bar code in the list of registered bar codes (see Figure 7.8) and click the **Del** button. Dialogue screen in Figure 7.10 appears for you to confirm the deletion. If it is okay to delete, click **Yes** button, otherwise click **No** button.

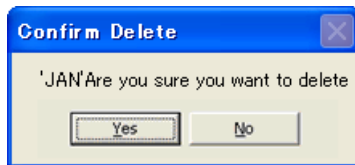

Figure 7.10

Detection of Terminal in Cradle and Low Battery Warning

If you check the **Cradle** and **Low Battery** boxes in STATE SETTING field (see Figure 7.11), the Simulator simulates the respective events in the emulator.

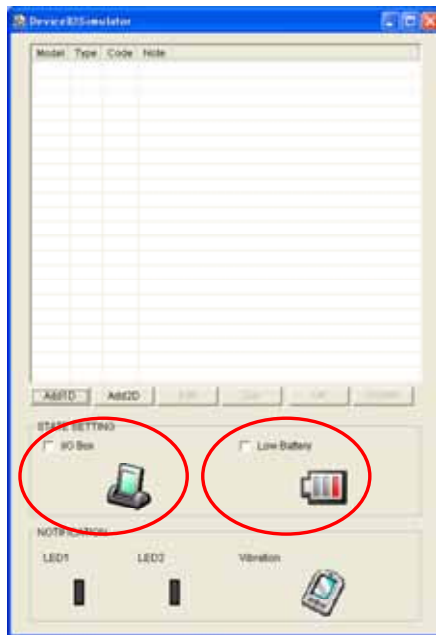

Figure 7.11

I/O Box

If this box is checked, a notification is issued that the connection between the **IT-9000WM Device Emulator** and cradle has been established. This notification can be utilized by the application.

Low Battery

If this box is checked, a notification that a low battery state has occurred is raised. The icon in the Toolbar in the emulated screen appears, too. The notification can be utilized by the application to recognize the low battery state in the hardware.

Indications

The **I/O Simulator** expresses a change of state that occurred in the **IT-9000WM Device Emulator**.

LED

When the **IT-9000WM Device Emulator** turns on the LED, the LED icon (LED2) in the **I/O Simulator** also turns on. See Figure 7.12.

Vibration

When the **IT-9000WM Device Emulator** vibrates, the vibration icon in the **I/O Simulator** also turns on. See Figure 7.12.

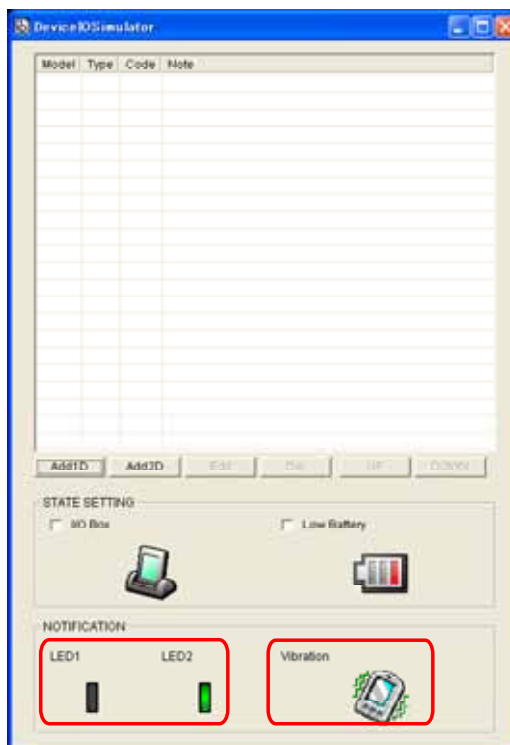

Figure 7.12

7.3.3 Connecting via ActiveSync

If debugging with the **IT-9000WM Device Emulator** is carried out in Visual Studio 2008 or Visual Studio 2005, or transmission/reception of a file with the **Device Emulator** is carried out, **ActiveSync** must be used.

Setting ActiveSync

1. Start up **ActiveSync** and then navigate to **File** → **Connection Settings**

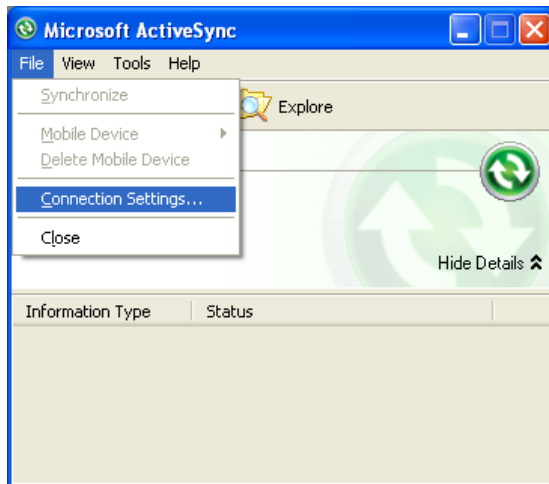

Figure 7.13

2. In **Connection Settings** screen, check in the **Allow connections to one of the following** box and choose **DMA** in the pull-down menu. See Figure 7.14.

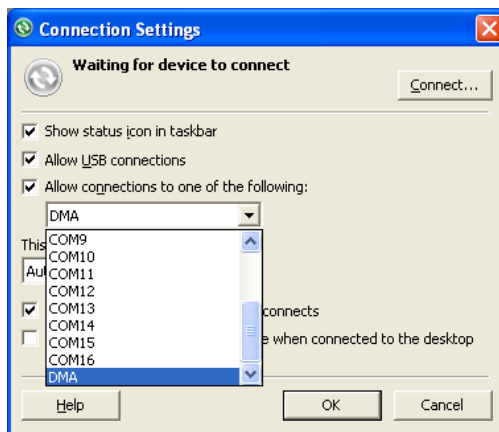

Figure 7.14

Connection via ActiveSync

The way to establish connection of the **Device Emulator** via **ActiveSync** is;

3. Start up the **Device Emulator** by referring to Chapter 7.2 "Starting Up the Device Emulator".
4. Start up Visual Studio 2008 or Visual Studio 2005, and then navigate to **Tools** → **Device Emulator Manager**. Right-click **IT-9000WM Emulator** in the list and then choose **Cradle** in the pop up menu. See Figure 7.15.



Figure 7.15



5. Make sure ActiveSync has started up and the  icon in the status bar changes to the  icon. See the emulated screen of IT-9000WM in Figure 7.16. The icon indicates that the connection via ActiveSync has been established.



Figure 7.16

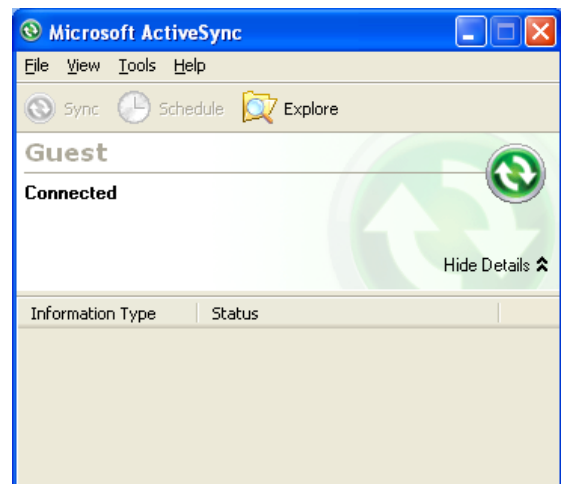

Figure 7.17

7.4 Debugging Applications

This chapter describes how to debug your application using the **Device Emulator**. Before starting to "Build", establish a connection between the **IT-9000WM Device Emulator** and your PC via ActiveSync by referring to Chapter 7.3 "Using the Device Emulator".

For the basic order of developing an application, refer to Chapter 8 "Visual Studio".

Setting Build Configuration

Choose **Debug** in the Solution Configurations pull-down menu in Visual Studio 2008 or Visual Studio 2005 and the **IT-9000WM Emulator** in the target device pull-down menu. See Figure 7.18.

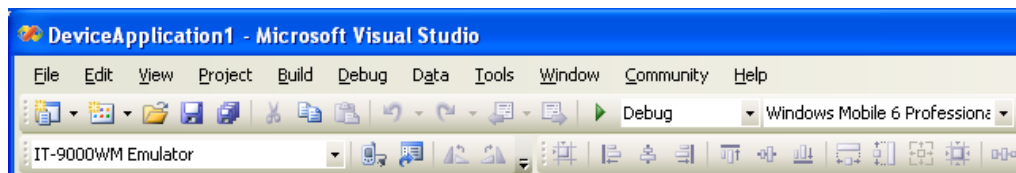

Figure 7.18

Debugging Applications

Basic Debug Operation

The debug operation used for the **Device Emulator** in Visual Studio 2008 or Visual Studio 2005 is the same as an ordinary debug operation using the actual terminal.

Debugging with the Device Emulator

With the **Device Emulator**, it is possible to set a break point in the source code of the application for step-by-step debugging.

1. Navigate to **Debug** menu → **Start Debugging** to start up the debugger.

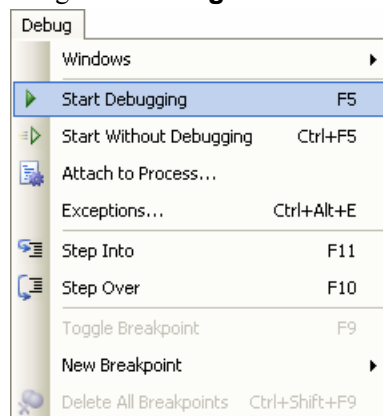

Figure 7.19

2. Similar to ordinary debugging operations with an actual IT-9000, the **Device Emulator** allows break point setting (circled in red in Figure 7.20) in the source code and step-by-step debugging.

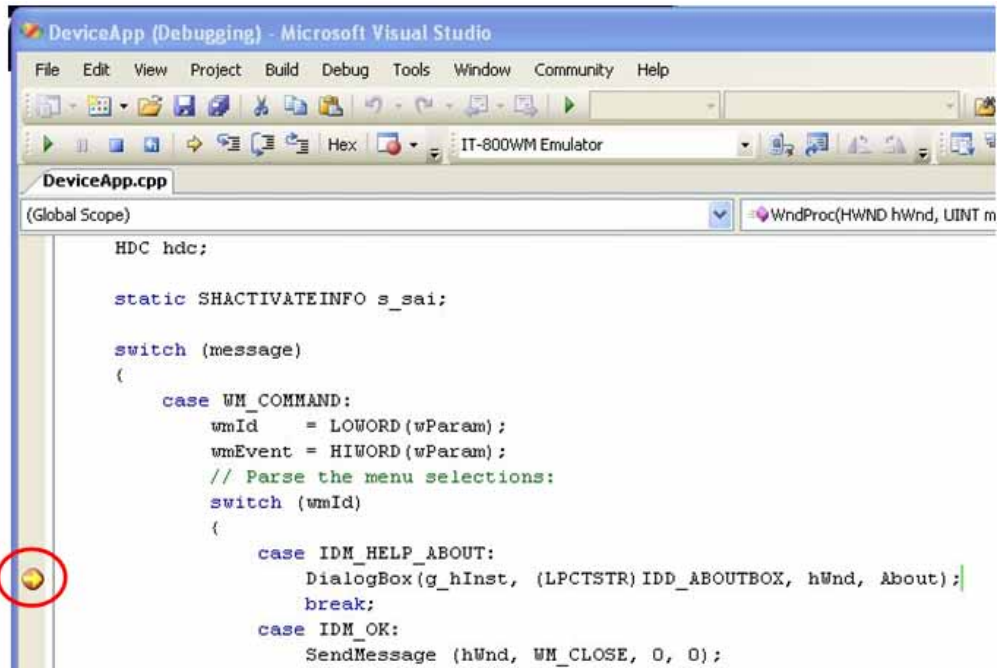

Figure 7.20

Note: If the Device Emulator does not allow break point setting in the source code step-by-step, install Microsoft .NET Compact Framework 2.0 SP2 into your PC.

.NET Compact Framework 2.0 Service Pack 2 --- Redistributable package

Microsoft .NET Compact Framework 2.0 SP2 can be downloaded from the following site:

<http://www.microsoft.com/download/en/details.aspx?displaylang=en&id=17981>

8. Visual Studio

This chapter describes application development steps in Visual Studio 2008 or Visual Studio 2005 to create an example program. The example program referred to in this chapter is an application program developed in three development environments - C++, Visual Basic.NET and C# - using the CASIO Common Device Control Library or Common Device Control Class Library. The example program for all three environments repeats turning on and off the LED to blink for a period of 5 seconds. See Chapters 8.1 "Developing in C++", 8.2 "Developing in VB.NET" and 8.3 "Developing in C#" for each development environment.

For the list of the libraries provided by the IT-9000WM BDK, refer to Chapter 1.2 "Library". For detail about each function of the Common Device Control Library and Common Device Control Class Library, refer to Common Device Control Library Manual.

The example program in this chapter runs also in the Device Emulator. To use the emulator, rename **IT-9000 Device** to **IT-9000 Emulator**.

Notes:

- Functions of the Common Device Control Library which control various individual devices integrated in IT-9000 have different name spaces and names from those available for the previous CASIO handheld terminals. They are not compatible with the ones in the previous CASIO library. The exceptions are DT-X7, DT-X11, and IT-600 that use the same libraries.
- Applications developed with any functions of CASIO dedicated library must be rewritten by replacing the dedicated functions with the appropriate functions from the Common Device Control Library.
- Take care when using Visual Studio 2008 or Visual Studio 2005 to upgrade an existing application and always keep a backup of your existing project.

8.1 Developing in C++

This chapter describes necessary steps to develop the example application program (see Chapter 8) in C++ environment using the Common Device Control Library.

Before proceeding to creating the project, check if the installation folder for the Common Device Control Library has been registered in Visual Studio 2008 or Visual Studio 2005 by following steps, 1 to 8, below.

1. Navigate to **Tools** → **Options ...** and open **Options** screen.
2. Navigate to **Projects and Solutions** → **Directories**.
3. Choose **Windows Mobile 6 Professional SDK (ARMV4I)** in **Platforms**.
4. Choose **Include files** in **Show directories for:**.
5. If the installation folder has not been registered, append the following.
C:\Program Files\CASIO\MBSYS\include
6. Choose **Library files** in **Show directories for:**.
7. If the files have not been registered, append the following.
C:\Program Files\CASIO\MBSYS\lib\ARMV4I
8. Click **OK** button to close the screen.

Application Development Procedure

Subsequent steps show how to create and start up a simple program using one of the system functions. When running the program, the LED will blink in red for 5 seconds.

1. First, create **Win32 Smart Device Project** with its device name **SmartDeviceApp** for Visual C++ in Visual Studio 2008 or Visual Studio 2005.
2. Choose **Pocket PC 2003** in the Selected SDKs (SDKs in the screen) field in the Platforms of Win32 Smart Device Project Wizard and click **<** button.

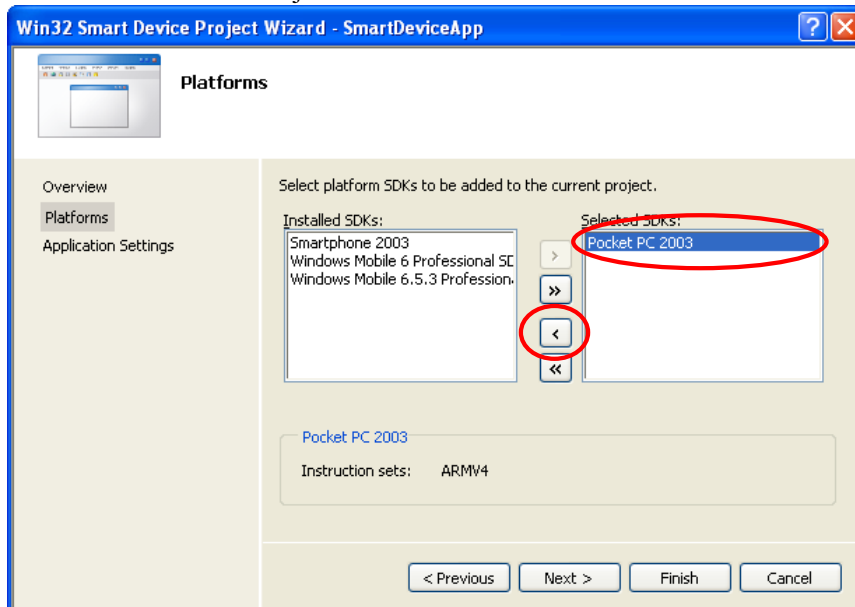

Figure 8.1

Choose **Windows Mobile 6 Professional SDK** in the **Installed SDKs** field and click **>** button.

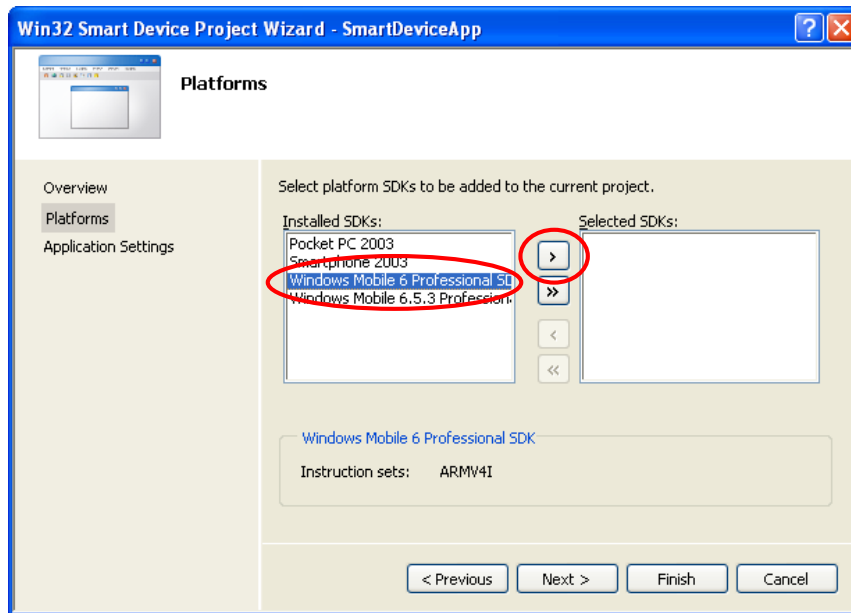

Figure 8.2

3. Click **Next >** button while **IT-9000** is kept being highlighted in the **Selected SDKs** field.

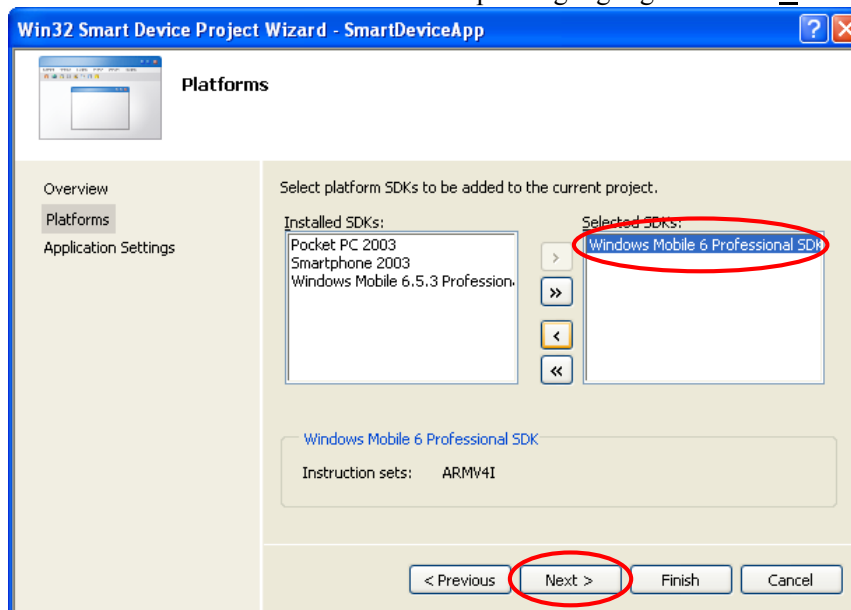

Figure 8.3

4. Choose Console Application for the Application type in the Application Settings menu, and click **Finish** button.
5. In Solution Explorer, click **SmartDeviceApp.cpp** and then append the source code below subsequent to "#include <commctrl.h>".

```
#include <SystemLib.h>
#if !defined(_countof)
#define _countof(_Array) (sizeof(_Array) / sizeof(_Array[0]))
#endif
```

6. Append the source code below in the main function of **SmartDeviceApp.cpp**.

```
DWORD result;
TCHAR msg[16];

result = SysSetLED(LED_RED, 5, 8, 8);

if(result == TRUE)
{
    result = SysGetLED();
    switch(result & 0x0000000F) {
    case LED_OFF:
        wcscpy_s( msg, _countof(msg), TEXT("LED_OFF") );
        break;
    case LED_RED:
        wcscpy_s( msg, _countof(msg), TEXT("LED_RED") );
        break;
    case LED_GREEN:
        wcscpy_s( msg, _countof(msg), TEXT("LED_GREEN") );
        break;
    case LED_ORANGE:
        wcscpy_s( msg, _countof(msg), TEXT("LED_ORANGE") );
        break;
    case LED_BLUE:
        wcscpy_s( msg, _countof(msg), TEXT("LED_BLUE") );
        break;
    case LED_CYAN:
        wcscpy_s( msg, _countof(msg), TEXT("LED_CYAN") );
        break;
    case LED_MAGENTA:
        wcscpy_s( msg, _countof(msg), TEXT("LED_MAGENTA") );
        break;
    default:
        wcscpy_s( msg, _countof(msg), TEXT("LED_UNKNOWN") );
        break;
    }
    MessageBox(NULL, msg, TEXT("LED"), MB_OK);
}
```

7. Choose **Properties** in the Project of Visual Studio 2008 or Visual Studio 2005, and navigate to **Configuration Properties** → **Linker** → **Input** → **Additional Dependencies** and then append **SystemLib.lib** (see red circle in Figure 8.4).

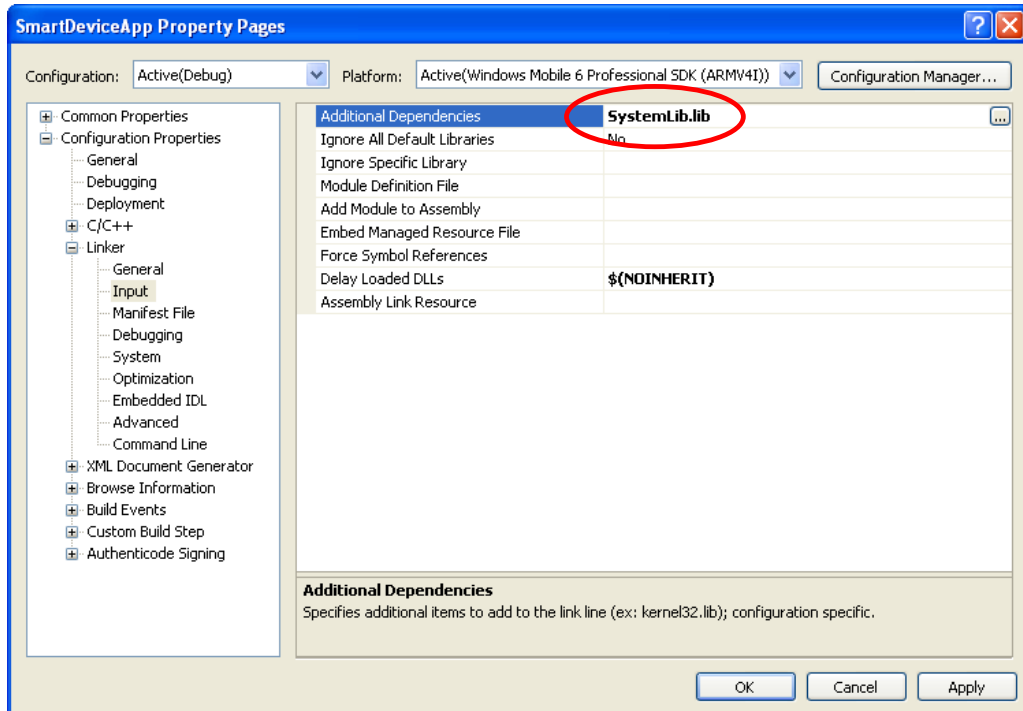

Figure 8.4

8. Choose **Windows Mobile 6 Professional Device** for the Target Device to establish connection with the PC.
9. Choose Debug in Visual Studio 2008 or Visual Studio 2005 and then click either Start Debugging or Start Without Debugging.
10. The project will be built and copied to the "\\Program Files\\<name of project>" folder by default in IT-9000.
11. Check that the program runs correctly on IT-9000.

8.2 Developing in VB.NET

This chapter describes necessary steps to develop the example application program (see Chapter 8) in VB.NET environment using the Common Device Control Class Library.

Application Development Procedure

Subsequent steps show how to create and start up a simple program using one of the system functions. When running the program, the LED will blink in red for 5 seconds.

1. Create a new VB.NET Smart Device Application in Visual Studio.
2. In Solution Explorer, right-click **References** and click **Add Reference...**
3. Click **Browse** and navigate to the folder where you have stored the CASIO .NET library files. Highlight **SystemLibNet.dll** and click it to open. Click **OK** button.

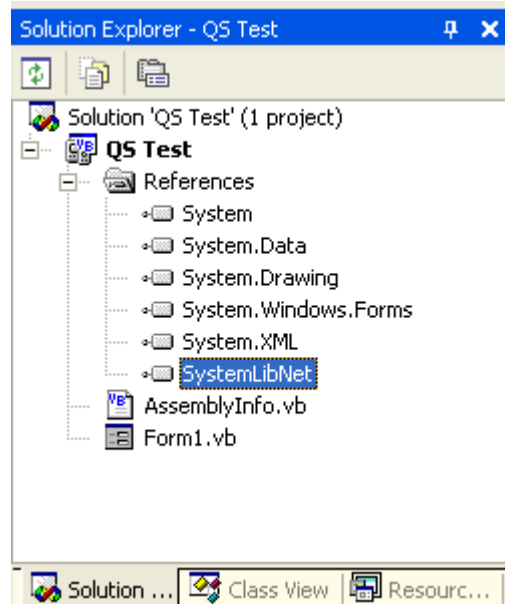

Figure 8.5

4. Add a button to the form, rename it **LED**, and double click it.

5. In the event function for the button to click, add the following code.

```
Dim result As Int32
Dim msg As String

result = Calib.SystemLibNet.Api.SysSetLED( _
    Calib.SystemLibNet.Def.LED_RED, 5, 8, 8)

'.NET vales of "true" and "false" are "-1" and "0" respectively.
If result = -1 Then
    result = Calib.SystemLibNet.Api.SysGetLED()
    Select Case (result And &HF)
        Case Calib.SystemLibNet.Def.LED_OFF
            msg = "LED_OFF"
        Case Calib.SystemLibNet.Def.LED_RED
            msg = "LED_RED"
        Case Calib.SystemLibNet.Def.LED_GREEN
            msg = "LED_GREEN"
        Case Calib.SystemLibNet.Def.LED_ORANGE
            msg = "LED_ORANGE"
        Case Calib.SystemLibNet.Def.LED_BLUE
            msg = "LED_BLUE"
        Case Calib.SystemLibNet.Def.LED_CYAN
            msg = "LED_CYAN"
        Case Calib.SystemLibNet.Def.LED_MAGENTA
            msg = "LED_MAGENTA"
        Case Else
            msg = "LED_UNKNOWN"
    End Select
    MessageBox.Show(msg, "LED")
End If
```

Note:

If you type this code manually you should see the IntelliSense offer you suitable options as appropriate. If you do not, make sure you review steps 1 to 5 to make sure you have added the reference correctly.

6. Choose **Windows Mobile 6 Professional Device** for the Target Device to establish connection with the PC.
7. Choose Deploy <name of project> on Build menu.
8. The source code will be compiled and the application will be copied to IT-9000. By default, it will be copied to **\Program Files\<name of project>** folder. **SystemLibNet.dll** will be deployed to the same folder.
9. Check that the program works correctly on IT-9000.

8.3 Developing in C#

This chapter describes necessary steps to develop the example application program (see Chapter 8) in C# environment using the Common Device Control Class Library.

Application Development Procedure

Subsequent steps show how to create and start up a simple program using one of the system functions. When running the program, the LED will blink in red for 5 seconds.

1. Create a new C# Smart Device Application in Visual Studio .NET.
2. In **Solution Explorer**, right click **References** and click **Add Reference...**
3. Click **Browse** and navigate to the folder where you have stored the CASIO .NET library files. Highlight **SystemLibNet.dll** and click **Open**. Click **OK** button.

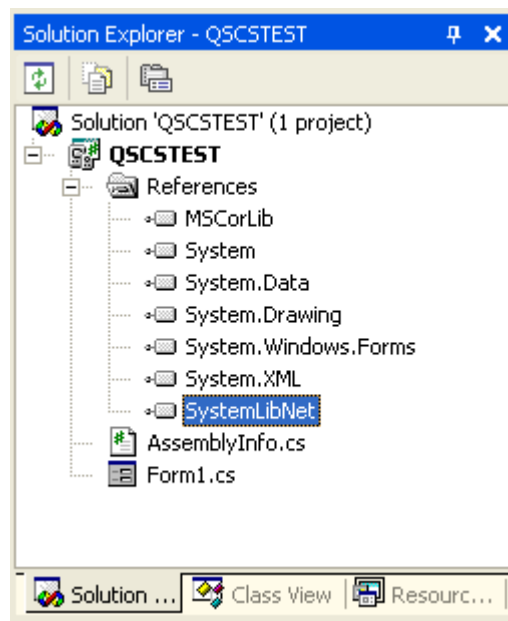

Figure 8.6

4. At the top of your source file add the following code.

```
using Calib;
```

5. Add a button to your form, rename it **LED** and double click it and then add the following code:

```
Int32 result = new Int32();
string msg;

result = SystemLibNet.Api.SysSetLED(SystemLibNet.Def.LED_RED, 5,
8, 8);

// .Net values "true" and "false" are "-1" and "0" respectively.
if(result == -1)
{
    result = SystemLibNet.Api.SysGetLED();
    switch(result & 0x0000000F)
    {
        case SystemLibNet.Def.LED_OFF:
            msg = "LED_OFF";
            break;
        case SystemLibNet.Def.LED_RED:
            msg = "LED_RED";
            break;
        case SystemLibNet.Def.LED_GREEN:
            msg = "LED_GREEN";
            break;
        case SystemLibNet.Def.LED_ORANGE:
            msg = "LED_ORANGE";
            break;
        case SystemLibNet.Def.LED_BLUE:
            msg = "LED_BLUE";
            break;
        case SystemLibNet.Def.LED_CYAN:
            msg = "LED_CYAN";
            break;
        case SystemLibNet.Def.LED_MAGENTA:
            msg = "LED_MAGENTA";
            break;
        default:
            msg = "LED_UNKNOWN";
            break;
    }
    MessageBox.Show( msg, "LED");
}
```

Note:

If you add this code manually you should see the IntelliSense offer you suitable options as appropriate. If you do not see this, then review steps 2 to 4 in the previous page to make sure you have not made a mistake.

6. Choose **Windows Mobile 6 Professional Device** for the Target Device to establish connection with the PC.
7. Select Deploy <name of project> on Build menu.
8. The source code will be compiled and the application will be copied to IT-9000. By default, it will be copied to \Program Files\<name of project> folder. **SystemLibNet.dll** will be deployed to the same folder.
9. Check that the program works correctly on the device.

9. Resources

Microsoft's own <http://msdn.microsoft.com/mobility/> is an extremely comprehensive resource for programmers targeting WindowsCE .NET based devices. It includes links to most other useful web based resources. You will find detailed Software and Library manuals on <http://world.casio.com/system/pa>.